

Owner's Manual for Narrow Configurations



ELEVATING
EFFICIENCY

Call us for information:
1-888-484-9376 (US)
(toll free in the United States)
450 589-8100 (Canada)



30053101-0-00000-0

P_NW_OpMan_v1.03_EN

© 2023 by Hydro Mobile, a division of BrandSafway Access, Inc. All rights reserved

This manual was produced by Hydro Mobile, a division of BrandSafway Access, Inc., on Adobe® InDesign CC® version 18.01 x64 for Windows®.

Technical drawings were prepared using Autodesk Inventor® 2020. Illustrations were created with Autodesk Inventor® 2020, Adobe® Illustrator CC® version 27.2 for Windows® and Adobe® Photoshop CC® version 24.1.1 for Windows®.

This manual may not, in whole or in part, be copied, photocopied, reproduced, translated, or converted to any electronic or machine readable form without prior written consent of Hydro Mobile

NOTE

All assembly and operation instructions located on the motorized unit and the bridges take precedence over information contained in this manual. Should there be any discrepancies discovered throughout any published documentation issued by Hydro Mobile or its authorized affiliates, the following order of precedence shall prevail:

1. Written documents issued by the Hydro Mobile Engineering department
2. Recall instructions
3. Assembly or operation instructions displayed on the motorized unit
4. Owner's manual

Any use of one or several Hydro Mobile motorized units, with or without accessories, in such a configuration or manner as not explicitly described in this manual is prohibited without the prior written permission of Hydro Mobile.

REVISION LIST		
Code / Version	Date	Description
30053102-0-00000-0 v1.02	December 2022	First edition of the manual
30053102-0-00000-0 v1.03	2023	Various corrections (typos, text standardization, etc.)

LEGEND OF ICONS

These icons are used to highlight important information throughout this manual



Danger
Immediate hazard: if not avoided, will result in serious injury, even death



Notice
Useful information to avoid equipment damage



Warning
Hazardous situation: if not avoided, could result in serious injury, even death and equipment damage



Information
Useful information for safe and easy operation



Caution
Potentially hazardous situation: if not avoided, may result in minor or moderate injury and equipment damage



Useful tip
A useful tip to facilitate installation or operation

GENERAL INFORMATION	
Motorized unit serial number	_____
Manufacturing date	_____



HYDRO MOBILE

www.hydro-mobile.com

125 de l'Industrie
L'Assomption, Quebec,
Canada J5W 2T9

For orders or information:
1-888-484-9376 (US)
(toll free in the United States)
(450) 589-8100 (Canada)

30053101-0-00000-0

TABLE OF CONTENTS

General Information

Introduction 5
 Warranty 6

Performance and Safety Rules

Performance and safety rules
 Definition of competent person 7
 Definition of qualified person 7
 General guidelines 7

1 - Motorized Unit

Overview 10
 List of components included with shipped unit 10
 Motorized unit specifications 11
 Weight of components 13
 Rear platform extension
 Opening the rear platform extension 13
 Closing the rear platform extension 13
 Dimensions of the motorized unit 14
 Bearing surface and cribbing requirements
 Minimum bearing surface capacities table 15
 Recommended cribbing 15
 Installation of a setup
 General guidelines 16
 Definition of a standard configuration 16
 Preparing the area for the installation 16
 Mandatory instructions for initial installation 17
 Installation of a standard single unit configuration 18
 Installation of a standard twin units configuration 19
 Dismantling an installation
 Safety guidelines 21
 Preparing the installation for dismantling 21
 Dismantling a standard single unit installation 21
 Dismantling a standard twin units installation 22

2 - Safety Devices

Inclinometer
 Connecting and resetting the inclinometers 24
 Testing the inclinometers 25
 Bringing the structure back to level 25
 Safety hooks system 26
 Fall protection 27
 Emergency descent procedure 28

3 - Bridges

Bridge types
 Multi-purpose bridge 29
 Multi-purpose cubic bridge 30
 Twin mast adapter – type NW 30
 Cantilever bridge 31
 Bearing bridge
 Safety guidelines 31
 Assembly of a bearing bridge structure 31
 Installation of a bearing bridge structure 32
 Dismantling a bearing bridge structure 32

4 - Power Pack and Operating Components

Startup preparation instructions 33
 Engine and motorized unit startup procedure 33
 Engine and motorized unit shutdown procedure 33
 Raising the platform 34
 Lowering the platform 36

5 - Mast and Mast Ties

Mast sections
 Installation of a single mast section 38
 Removal of a single mast section 38
 Transport and storage of mast sections 39
 Mast ties
 Installation of tie levels
 Tie level installation schedule 39
 Wind speeds warning 39
 Mast tie requirements 40
 Installation of mast ties 41
 Passing tie levels 41
 Removal of mast ties 42

5 - Mast and Mast Ties (cont'd)

Mast ties (cont'd)
 Angled mast ties 42
 Installation of the mast tie attachment assembly 42
 Installation of the angle bracket 43
 Assembly of an extended mast tie 43
 Installation of extended mast ties 44
 Anchoring system
 Wall tie reactions 45
 Installation of wall ties 45
 Wall tie types 45
 Guidelines for horizontal anchoring 46
 Guidelines for a re-usable wall tie 46
 Guidelines for a fixed wall tie 46
 Guidelines for a welded wall tie on a beam 46

6 - Load Capacities

Load capacities
 General guidelines 47
 Single unit setup 48
 Twin units setup 49

7 - Accessories

Safety accessories
 Guardrails included with the P Series narrow motorized unit 50
 Required optional guardrails 50
 Guardrails required for typical single unit configurations 50
 Guardrails required for a typical twin unit configuration 50
 Installation of a guardrail adapter bracket 51
 Installation of a 73 3/4" (187.5 cm) guardrail 51
 Installation of a 27" (69 cm) guardrail 51
 Adjustment of gap fillers 51
 Installation of a 33" (84 cm) guardrail 51
 Installation of a guardrail on a multi-purpose bridge (standard or cubic) 52
 Installation of a universal twin mast adapter guardrail 52
 Plank-end guardrail 52
 Face guardrail supports 52
 Movable guardrail 53
 Universal plank safety support 53
 Access stairs 53
 Other accessories
 Outriggers 54
 Multiple mast handler 54
 General guidelines 54
 Installation of assembled lengths of mast sections 55
 Removal of assembled lengths of mast sections 55

8 - Transport, Storage and Maintenance

Transport and storage
 Preparation of the motorized unit 56
 Storage of the motorized unit guardrails 56
 Storage of a bridge 58
 Storage of a twin mast adapter 58
 Storage of a mast section 58
 Storage of a guardrail 58
 Storage of the access stairs 59
 Storage of the control post 59
 Storage of the motorized unit 59
 Lifting and moving a motorized unit or a setup 60
 Inspections and maintenance
 Inspection and maintenance of the cylinder hook 61
 Replacement of the rubber of the cylinder hook 61
 Greasing the mast carriage guide rollers 62
 Inspecting and greasing the safety hooks 62
 Daily and weekly inspections and maintenance 63
 Frequent inspections and maintenance 63
 Annual inspections and maintenance 64
 Samples of checklists 64
 Stickers included on motorized unit 65
 Hydraulic diagram 68
 Electric diagram 69

Introduction

Dear owner or user:

Thank you for investing in a Hydro Mobile P Series mast climbing work platform system for narrow configurations. The design of this motorized unit reflects years of continued field operation, testing and research work and comes as a solution to our company's deepest concern, your safety and well-being on the job.

To ensure that the workplace becomes safer and more efficient using a Hydro Mobile system, always have appropriately trained personnel assemble, operate, dismantle and move your mast climbing work platform system. These qualified persons will be required to read this owner's manual and assimilate the information contained herein. Failure to do so could lead to serious injury and/or equipment damage.

This motorized unit was designed in accordance with the following standards: US ANSI A92.9-2011, CAN/CSA B354.9-17, ISO 16369:2007 and EN 1495. Furthermore, this motorized unit and the owner's manual comply with US ANSI A92.9-2011 standards, Federal Occupational Safety and Health Administration Standards OSHA 29CFR1926 subpart L; with ISO 16369:2007, CAN/CSA B354.10-17 and CAN/CSA B354.11-17; and with EN 1495.

To ensure safety, maximize the life expectancy of your equipment and to enjoy years of dependable and secure operation, this Hydro Mobile system must be serviced according to maintenance schedules and recommendations provided in this manual. It is also advised to refer to the engine or motor user's manual included with the motorized unit.

Should you have any questions or concerns, please contact the nearest authorized service center or Hydro Mobile directly at 888-484-9376 (in the United States) or at 450 589-8100 (in Canada). You can also visit our website at www.hydro-mobile.com for additional support and information on our factory safety and performance training seminars.

We wish you years and years of safe, productive construction and renovation work.



WARNING

To ensure that the workplace becomes safer and more efficient using a Hydro Mobile system, always have appropriately trained personnel assemble, operate, dismantle, transfer and maintain your work platform system. These qualified persons will be required to read this owner's manual and assimilate the information contained herein. Failure to do so could lead to serious injury and/or equipment damage.

Hydro Mobile Warranty Policy

Warranty period

Hydro Mobile, a division of BrandSafway Access, Inc., herein referred to as Hydro Mobile, warrants its new P Series motorized units to be free from defect of materials and workmanship for a period of 15 months from the date of delivery to the authorized distributor/service center.

Hydro Mobile also warrants its new P Series parts and accessories to be free from defect of materials and workmanship for a period of 15 months from the date of delivery to the authorized distributor/service center.

P SERIES

Product registration

In accordance with standards governing mast climbing work platform systems, the owner of a Hydro Mobile P Series unit **must register the product with Hydro Mobile within sixty (60) days**. The initial buyer of a Hydro Mobile P Series unit is automatically registered by Hydro Mobile.

Hydro Mobile must be kept informed of any change of ownership. The new owner must provide Hydro Mobile with a full name and address, along with the model and serial number of the unit acquired.

Description of warranty

Parts and accessories manufactured by Hydro Mobile

Hydro Mobile's obligation and liability under this warranty are expressly limited to repairing or replacing with re-manufactured or new parts, at Hydro Mobile's option, any part and accessory manufactured by Hydro Mobile proven defective after inspection by Hydro Mobile which appear to have been defective in material or workmanship. Only permanent repairs will be covered under this warranty. Hydro Mobile reserves the right to ask for maintenance records of the defective part before settling a claim and to deny such claim if maintenance records are not available or not compliant with maintenance schedules.

This warranty shall not apply to component parts or accessories of products not manufactured by Hydro Mobile and which carry the warranty of the manufacturer thereof or to normal maintenance (such as engine tune-up) or any part necessary to perform such maintenance. Hydro Mobile offers no other warranty, expressed or implied, and offers no warranty of merchantability or fitness for any particular purpose.

Engine

All engines manufactured by Honda under the "GX" lineup are covered by an international warranty of 36 months (12 months on mufflers) and 36 months for Toshiba electric motors. To have an engine repaired under this warranty, the engine must be brought to an authorized Hydro Mobile distributor/service center or to an authorized Honda or Toshiba service center.

Battery

All the batteries shipped from the factory with new equipment are guaranteed for a period of 60 days. Any battery discharged due to operator error will not be covered under this warranty. Dead batteries that can be recharged will not be replaced under this warranty.

Costs and liability associated with warranty

Hydro Mobile's obligation under such warranty shall not include duty, taxes or any other charge whatsoever, or any liability for direct, indirect, incidental or consequential damage or delay.

Exclusion

Any use of one or several Hydro Mobile motorized units, with or without accessories, in such a configuration or manner as not explicitly described in the owner's manual is prohibited without the prior written permission of Hydro Mobile.

Any improper use, including operation after discovery of defective or worn parts, shall void this warranty. Improper use also includes operation beyond rated capacity, substitution of parts other than those approved by Hydro Mobile, including anchor systems, or any alteration, modification or repair by others in such manner as in Hydro Mobile's judgment affects the product materially and adversely.

Labor

All warranty work must be performed by a certified Hydro Mobile technician to be eligible for reimbursement under the warranty.

Performance and Safety Rules



SAFETY comes first. The installation and operation of a mast climber is subject to hazards that can be avoided only by using extreme care and common sense, and by providing the **appropriate training and supervision** to all its users.

It is essential that the **installation and dismantling** of P Series narrow motorized unit and its related accessories be carried out according to the guidelines, instructions and warnings included in the owner's manual and performed by **qualified erectors/dismantlers** under the supervision of a **competent person** (see boxes below).

It is also imperative that the **operation** of P Series narrow motorized unit setup be carried out according to the guidelines, instructions and warnings included in the owner's manual. To ensure safe and proper operation, Hydro Mobile recommends that **two persons** be on hand to perform maneuvers for **each motorized unit in a setup** and that **at least one of those two persons is a qualified operator** (see box below) for a P Series narrow motorized unit and its accessories.

N

NOTICE

The P Series narrow configurations and the methods to achieve these configurations as shown and described in this owner's manual are the only ones authorized by Hydro Mobile.

Definition of the competent person

Competent person means a person who is capable of identifying existing and predictable hazards in the surroundings or working conditions which are unsanitary, hazardous or dangerous to employees, and who has authorization to take prompt corrective measures to eliminate them.

Definition of the qualified person

"**Qualified**" means a person who, by possession of a recognized degree, certificate or professional standing, or who by extensive knowledge, training and experience, has successfully demonstrated the ability to solve or resolve problems relating to the subject matter, the work or the project.

Only a **qualified person** on the specific make and model of the Hydro Mobile equipment can carry out the following tasks:

User/operator

A **qualified user/operator** is allowed to operate Hydro Mobile units according to the guidelines, instructions, warnings and methods set out in the owner's manuals and Hydro Mobile training courses and after they have been erected, tested and passed for use by a qualified person.

Erector/dismantler

A **qualified erector/dismantler** is allowed to erect, dismantle, test, pass for use and modify the configuration of Hydro Mobile units according to the guidelines, instructions, warnings and methods set out in the owner's manuals and Hydro Mobile training courses.

Technician

A **qualified technician** is allowed to perform maintenance inspections and repairs on Hydro Mobile units according to the guidelines, instructions, warnings and methods set out in the owner's manuals and Hydro Mobile training courses.

Hydro Mobile recommends that Qualified Persons follow the Hydro Mobile University Training Program on the specific task and specific make and model to get proper qualifications. For more information on the Hydro Mobile University Training Program, visit www.hydro-mobile.com/training

General guidelines

- 1- Make sure that a job survey - job hazard analysis has been performed. Refer to p. 64 of the *Transport, Storage and Maintenance* section for more information about the job survey – job hazard form.
- 2- Prepare a layout plan showing how the mast climbing work platform system (motorized units, bridges and accessories) will be positioned near structures or walls to be erected. On long walls, install separate mast climber sections to allow for flexibility. Make sure to position the motorized units so as to provide proper anchoring points for masts.
- 3- For each setup and configuration, a job/task-specific installation and dismantling procedure for any Hydro Mobile equipment used must be compiled in consultation with and approved by a qualified person before proceeding with the installation or dismantling of the equipment. The procedure must be part of the *Safe Work Plan* (SWP) and must be reviewed in pre-task planning/tool-box talks.
- 4- It is **mandatory** to refer to the *Tie Level Installation Schedule* table on p. 39 of the *Mast and Mast Ties* section and to the *Load Capacities* section on p. 47 **before the installation** of any P Series narrow mast climbing work platform setup.

Performance and Safety Rules

- 5- Establish the distance between the mast climbing transport platform system and the structure or wall, taking into account curvatures, balconies, columns, trees, telephone wires, electrical lines, etc.
- 6- Refer to and follow local regulations governing distances between the mast climbing work platform system and electrical lines. As a reference, North American regulations generally recommend keeping a minimum safe approach distance (MSAD) of at least 10' (3 m) from overhead power lines carrying 50 000 volts or less.
- 7- Make sure the ground or support surface capacity meets with values included in the *Minimum Bearing Surface Capacities* on p. 15 of the *Motorized Unit* section. Soil compacting, cribbing or shoring can increase bearing capacity. The **jacks on the base** are designed to **level the motorized unit**, plumb the mast, and support the load. Contact a licensed engineer for assistance.
- 8- Never modify the mast climbing work platform system (including the motorized unit) or use substitute parts. This could adversely affect worker safety, unit performance and void the warranty. In addition, this could lead to serious injury or death.
- 9- Never use a gas-powered P Series narrow motorized unit in an enclosed space due to carbon monoxide emissions or in a place where explosives are stored.
- 10- Each P Series narrow motorized unit must be equipped with an appropriate fire extinguisher (not supplied). Use the bracket supplied with the motorized unit to hang the fire extinguisher in a readily accessible location (fig. 1.5, p. 10).
- 11- It is recommended not to smoke on the platform.
- 12- Workers exposed to potential hazards must always wear proper personal protection equipment (PPE) such as a helmet, safety boots, a fall arrest harness, etc., as prescribed by local regulations. In all cases where workers are exposed to fall hazards, fall protection is required. Installation of all the necessary guardrails is **mandatory**. Tie points located on the motorized unit (fig. 1.2, p. 10) are designed to resist to a maximum arrest force of 5000 lb (2268 kg) and can be used by workers to tie themselves to the unit (not more than one worker per tie point).
- 13- No load must be applied on a guardrail. Material must be stored away from guardrails. It is also forbidden for anyone to lean on a guardrail.
- 14- The P Series narrow motorized unit **must not be used on a mast with a height over 250' (76 m)**.
- 15- The P Series narrow motorized unit **must not be used** with any equipment or any accessories not specifically manufactured and rated by Hydro Mobile to be used with P Series narrow motorized units.
- 16- To ensure work efficiency, maintain an adequate equipment and parts inventory on the job site. Keep equipment in good condition.
- 17- Planks used for planking must be scaffold graded (SPF), in good condition and meet local regulations.
- 18- **IMPORTANT:** It is strongly recommended not to use equipment that generates vibrations or reactions on Hydro Mobile platforms.
- 19- Inspection and maintenance operations must be carried out efficiently and in a timely manner. Daily inspections and their related operations must be performed by a **qualified user/operator** every day or before every working shift. Frequent and annual inspections and their related operations must be carried out by a **qualified technician**. Refer to the *Transport and Storage* section on p. 61 for more information on inspection and maintenance requirements for P Series narrow motorized units and their accessories. For the definition of a qualified user/operator or a qualified technician, refer to p. 7 of this section.
- 20- The **qualified erectors/dismantlers** in charge of the installation must make sure that the equipment being installed has been duly inspected and meets all applicable safety standards.
- 21- **Prior to installation, prepare an emergency evacuation plan that is specific to the job site and is in accordance with local regulations.**
- 22- Make sure that there is a **reliable and adequate** alternate power source available (generator, extension cord, etc.) to supply the emergency descent system (120 volts in North America, 240 volts in Europe).
- 23- After installation, mark off limit areas of the system using fencing, barriers, warning tape and note emergency phone numbers (fire and police dept.) for quick reference.

Performance and Safety Rules

- 24- **Never load bridges or motorized units beyond their rated capacities.** Overloading may bring damages to equipment or cause the installation to become unbalanced, leading to serious injury or death.
- 25- Contact the distributor/service center for service, repair or technical advice. Refer to equipment type and serial number when calling.
- 26- Each person must access the platform by an optional access stairs (sold separately), a staircase or through an opening in the building. In all cases, transfer must be safe and free from obstruction.
- 27- The use of appropriate fall protection equipment is **mandatory** when installing or removing mast sections and tie levels, when modifying plank configuration or whenever the worker is exposed to a fall hazard. Failure to use fall protection equipment can expose the user to serious injury or death. Refer to local regulations for more information.
- 28- When the motorized unit is moving, it is **mandatory** for all workers to stand in an area on the platform close to the rear guardrails.
- 29- In the event of an abnormal occurrence or operation which could compromise safety (for example, malfunction of a motorized unit component, collision with an obstacle, etc.), immobilize the unit and inform the **competent person**. For the definition of a competent person, refer to p. 7 of this section.
- 30- **Do NOT** touch any of the moving parts on the work platform system when it is in use.
- 31- All access doors and panels on the motorized unit must be closed when they are not in use. All access doors and panels must be free from any material or obstruction.
- 32- The motorized unit must not be used or operated during an electrical thunderstorm. A motorized unit that is exposed to a thunderstorm must be submitted to a daily inspection by a qualified person before operation can be resumed. For the definition of a qualified person, refer to p. 7 of this section.
- 33- The deposit of loads on the platform must be done with extreme care, under proper supervision, and the stability of the installation must be ensured at all times. Refer to the *Load Capacities* section on p. 47 for more information about loads allowed on the platform.

N	NOTICE
It is not allowed to climb up or down the mast on P Series narrow motorized unit setups.	

	WARNING
<p>The erection and dismantling of a motorized unit setup (including the base, the bridges, the masts, the mast ties and all the other components) must not be conducted when wind speeds exceed 28 mph (45 km/h). Freestanding installations and setups equipped with weather protection, when allowed, must not be used with wind speeds exceeding 28 mph (45 km/h). Weather protection, when allowed, must not be used when work is performed on an open air structure. A motorized unit setup with mast ties must not be used when wind speeds exceed 35 mph (56 km/h). It is important to inspect every component of a motorized unit installation that has been exposed to conditions that could have compromised or altered the structural integrity and stability of the installation.</p> <p>When the motorized unit is not in use:</p> <ul style="list-style-type: none"> • It is mandatory to bring the platform down to base level or to leave the platform between two tie levels. • All loads must be removed from the platform. • It is mandatory to leave all the counterweights applied on the setup in place. • In a freestanding installation, when allowed, the motorized unit must be brought down to base level. • If wind speeds are expected to exceed 94 mph (150 km/h), the motorized unit must be brought down to base level. 	

	WARNING
<p>It is mandatory to refer to the <i>Tie Level Installation Schedule</i> table on p. 39 of the <i>Mast and Mast Ties</i> section before the installation of any P Series narrow motorized unit setup.</p>	

Motorized Unit Motorized unit – Overview

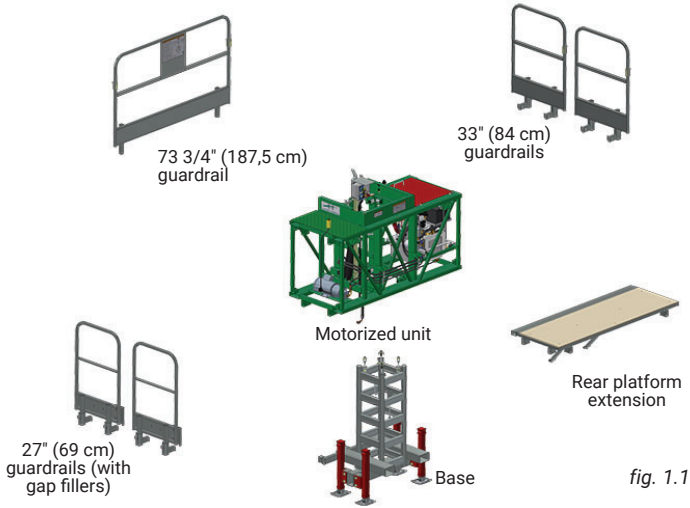

Note: Items depicted in illustrations throughout this manual may differ from actual products.

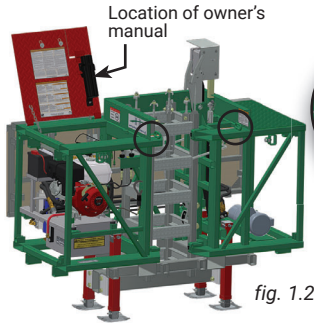

Designated tie points on unit



Crank handle for jacks



Support for fire extinguisher

fig. 1.6

List of components included with shipped unit			
Qty	Component	Qty	Component
1	P Series narrow motorized unit	1	73 3/4" (187,5 cm) guardrail
1	Owner's manual	10	Guardrail adapter brackets
1	Rear platform extension	1	Crank handle for jacks
2	33" (84 cm) guardrails	1	Support for fire extinguisher
2	27" (69 cm) guardrails (with gap fillers)	1	15/16" open end wrench

Notes
 The P Series narrow motorized unit is shipped without any outriggers
 The list of components included with each shipped motorized unit may change without notice.

Motorized Unit

Motorized Unit Specifications

fig. 1.7

General Specifications		
Dimensions of the motorized unit (as shipped)	44 1/4" x 83 11/16" x 73 1/2" (W x L x H) (112 cm x 213 cm x 186 cm)	
Drive system	Hydraulic ratchet drive	
Maximum height	250' (76 m)	
Freestanding	Not allowed	
Distance between tie levels	Up to 20' (6,1 m) (refer to <i>Mast and Mast Ties</i> section for complete information)	
Safety devices	Emergency descent	Independent electrical descent control system
	Safety hooks	Speed-activated hook system
	Inclinometer (included with twin mast adapter)	Slope detection switch

fig. 1.8

Specific Features		
Platform weight (as shipped)	Total	2000 lb (907 kg) (fully assembled)
	Base	450 lb (204 kg)
	MU structure assembly	1550 lb (703 kg)
Maximum load capacity	Single unit installation	7000 lb at 16'-9" (3176 kg at 5,1 m) 4600 lb at 37'-6" (2086 kg at 11,4 m)
	Twin units installation	11 500 lb at 74'-8" (5216 kg at 22,8 m) 9750 lb at 95'-5" (4423 kg at 29,1 m)
Maximum lifting capacity		7700 lb (3493 kg)
Vertical travel speed		7' (2,1 m) per minute (Honda 9 HP engine)
Mast section		16" x 16" x 60" (40,6 cm x 40,6 cm x 1,5 m) 235 lb (107 kg) per section
Main accessories (sold separately)	Multi-purpose bridge	33 1/4" x 62 1/4" x 35 13/16" (W x L x H) (84,5 cm x 158 cm x 91 cm)
	Multi-purpose cubic bridge	33 7/8" x 33 1/2" x 35 13/16" (W x L x H) (86,5 cm x 85,5 cm x 91 cm)
	Twin mast adapter - NW type	29 1/8" x 35 9/16" x 35 13/16" (W x L x H) (74 cm x 90 cm x 91 cm)
Guardrails (included)		27" (69 cm) (2) (with gap fillers) 33" (84 cm) (2) 73 3/4" (187,5 cm) (1)

fig. 1.9

Hydraulic Specifications	
Component	Specifications
Single gear pump	1 x 7,38 GPM (27,9 l/min)
Hydraulic cylinder	1 x 3 1/2" x 23 1/2" x 1 1/2" (8,9 cm x 59,7 cm x 3,8 cm) with 3000 psi counterbalance
Hydraulic tank capacity	6,28 US gal (23,75 l)
Hydraulic oil	Dexron III ATF
Oil filter	Ikon filter model HE K44-20-135-A5-SP010 (HM part number A0410000-0004)

Motorized Unit

Motorized Unit Specifications

fig. 1.10

Engine Specifications	
Model	Honda GX270
Rated power	9 HP @ 3600 rpm
Fuel consumption in continuous service	2,5 US qt/hour (2,4 l/hour) @ 3600 rpm
Spark plug	BPR6ES
Oil type	SAE 5W30
Gasoline tank capacity	1,71 US gal (6,5 l)
Oil capacity	1,16 US qt (1,1 l)
Electrical power supply	12 VDC - 10 ampere-hour
Battery	12 V - 700 CCA
For any other information regarding the use and the maintenance of Honda engines, refer to the Honda User's manual	

fig. 1.11

Operation Specifications		
Wind exposure		
Situation	Maximum wind speed allowed	
	In service	Out of service
Erection / dismantling	28 mph (45 km/h)	Does not apply
Freestanding setup (when allowed)	28 mph (45 km/h)	Unit must be brought down to base level
Setup equipped with weather protection (when allowed)	28 mph (45 km/h)	Unit must be brought down to base level
Setup with mast ties	35 mph (56 km/h)	94 mph (150 km/h) Loads unloaded from platform and unit between two tie levels
If wind speeds are expected to exceed 94 mph (150 km/h), the motorized unit must be brought down to base level		
Ambient temperature		
Ambient temperature range for operation	-4°F to 104°F (-15°C to 40°C)	
Noise exposure		
Standard noise level		
(DB-A / 7 m) @ 3600 rpm	79 dBA	

Motorized Unit

Motorized Unit Specifications

fig. 1.12

UNIT and components		BRIDGES	
Description	Weight	Description	Weight
P Series narrow motorized unit (as shipped)	2000 lb (907 kg)	Narrow twin mast adapter (without guardrail)	198 lb (90 kg)
P Series narrow base assembly	450 lb (204 kg)	Multi-purpose bridge (with 33" or 84 cm guardrail)	310 lb (141 kg)
P Series rear platform extension assembly	275 lb (125 kg)	Cubic bridge (without guardrail)	155 lb (70 kg)
MAST and MAST TIES		GUARDRAILS	
Description	Weight	Description	Weight
Mast assembly	235 lb (107 kg)	73 3/4" (187,5 cm) guardrail	63 lb (29 kg)
Mast tie attachment assembly for narrow setup	42 lb (19 kg)	60" (152 cm) guardrail (with adapter bracket)	58 lb (26 kg)
Mast tie attachment assembly	25 lb (11 kg)	33" (84 cm) guardrail (with adapter bracket)	42 lb (19 kg)
Mast tie assembly	16 lb (7 kg)	30" (76 cm) guardrail (with adapter bracket)	40 lb (18 kg)
Mast tie extension	13 lb (6 kg)	27" (69 cm) guardrail (with gap filler and brackets)	43 lb (19,5 kg)
Mast tie 30-degree kit	15 lb (6,8 kg)	Universal guardrail for twin mast adapter	42 lb (19 kg)
OUTRIGGERS		ACCESSORIES	
Description	Weight	Description	Weight
32" (81,3 cm) outrigger	8 lb (4 kg)	Access stairs assembly	76 lb (34,5 kg)
63" (160 cm) outrigger	18 lb (8,2 kg)	Access stairs handrail	21 lb (10 kg)
72" (183 cm) outrigger	27 lb (12,3 kg)	Access stairs extension	23 lb (10,4 kg)
84" (213 cm) outrigger	45 lb (20 kg)	Multiple mast handler	16 lb (7 kg)
Cross box	4 lb (2 kg)		

Rear Platform Extension on the Motorized Unit

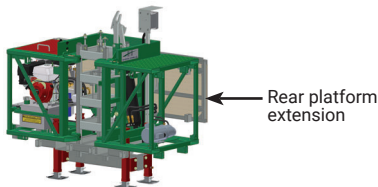

fig. 1.13



fig. 1.15

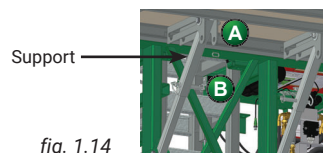

fig. 1.14

Support structure for the rear platform extension



fig. 1.16

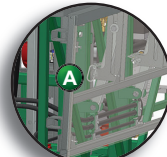

fig. 1.17

Opening the rear platform extension

- 1- Make sure the motorized unit is at base level. Remove the pins (2) locking the supports in storage position (see "B" in fig. 1.14 and fig. 1.15).
- 2- Lift and support the platform extension.
- 3- Insert a locking pin in each of the supports to secure the platform extension in working position (see "B" in fig. 1.15).

Closing the rear platform extension

- 1- Make sure the motorized unit is at base level. Slightly lift and support the platform extension. Remove the two pins locking the platform extension in working position (see "B" in fig. 1.15).
- 2- Lower the extension carefully until each support tube has retracted completely (fig. 1.16).
- 3- Insert a locking pin in the supports to secure the platform extension in storage position (fig. 1.17).

Motorized Unit

Dimensions of the Motorized Unit

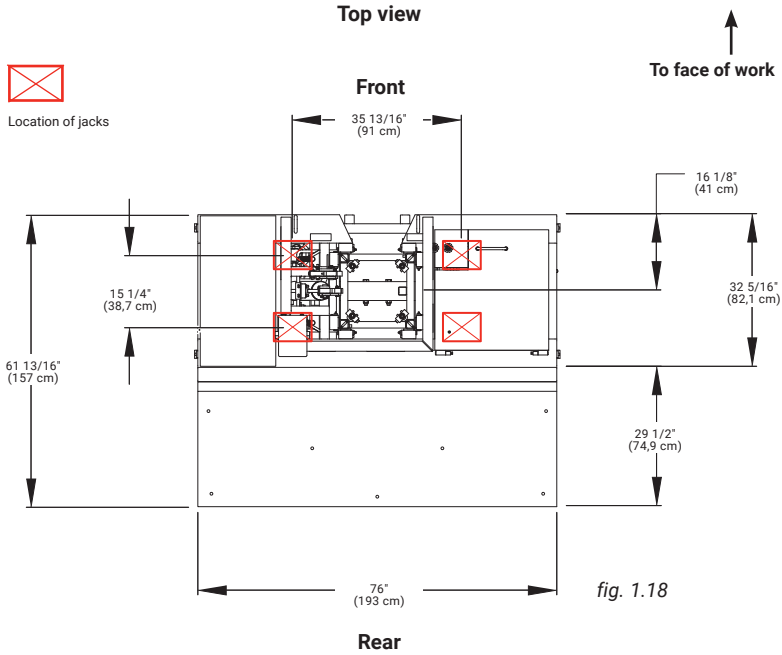

The distance from the face of the work to the motorized unit must be equal to the width of one plank multiplied by the number of planks in the configuration, while allowing 6" to 8" (15 cm to 20 cm) of play. The standard, recommended plank configuration for a P Series motorized unit (standard or narrow) installation is two planks.

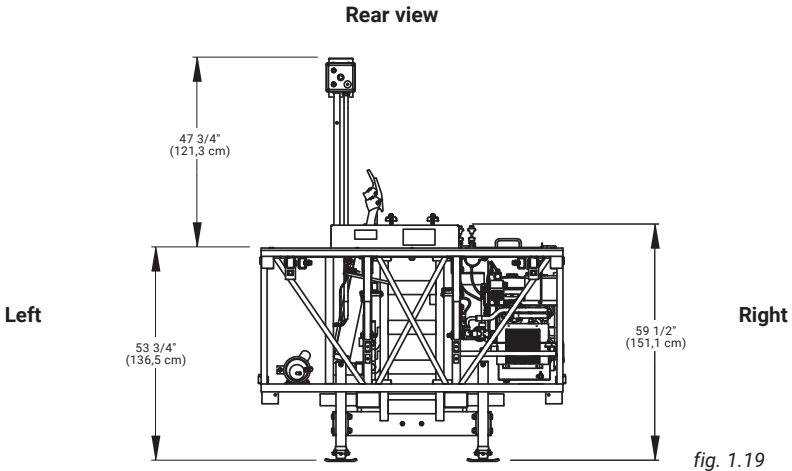

Motorized Unit

Bearing Surface and Cribbing Requirements

Bearing surface

Before installing the motorized unit, make sure the bearing surface under it is level, clear of debris and has the proper bearing capacity. When required, appropriate cribbing must be placed under the jacks to distribute the load. It is important to make sure that the bearing surface is stable and has not been subject to any type of erosion or deterioration caused by weather conditions (snow, rain, etc.).

The type of cribbing chosen may vary according to the bearing surface where the setup must be installed.

For example, a setup installed on a concrete slab that is covering the bearing surface may require cribbing consisting of only one plywood panel under the base while a setup installed on a concrete slab that is covering an indoor garage may require shoring in addition to plywood cribbing.

A setup installed on a bearing surface composed of gravel, sand or any such type of surface would require stronger cribbing under the jacks.

In cases where shoring is required, it is recommended to contact an engineer for assistance.

Minimum Bearing Surface Capacities					
Height		Load on each main jack (4)		Load under mast	
ft	m	lb	kg	lb	kg
20	6,1	2621	1189	10 485	4756
50	15,2	3021	1370	12 082	5480
75	22,9	3338	1514	13 352	6056
100	30,5	3655	1658	14 620	6632
200	61	4924	2233	19 695	8934
250	76,2	5558	2521	22 233	10 085

* Load reactions in this table include a dynamic factor

fig. 1.20

WARNING

Make sure the ground or support surface capacity meets with values included in the *Minimum Bearing Surface Capacities* table (fig. 1.20). Soil compacting, cribbing or shoring can increase bearing capacity. Any cribbing product or cribbing method approved by the site engineer can be used to distribute the load on the bearing surface providing it meets the values in the *Minimum Bearing Surface Capacities* table (fig. 1.20). Contact an engineer for assistance.

Recommended cribbing for most bearing surfaces

The plywood and lumber used as cribbing must be secured together to prevent slipping.

Recommended Cribbing Pad		
40' x 40' x 6" (102 cm x 102 cm x 15 cm)		
①	Plywood 40' x 40' x 3/4" (102 cm x 102 cm x 2 cm)	2
②	Lumber 2' x 10' x 40" (5 cm x 25 cm x 102 cm)	12

fig. 1.21

Values shown in the above table are for reference only.

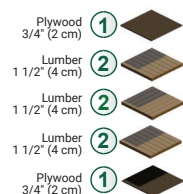

fig. 1.22

Motorized Unit

Installation of a Setup



SAFETY comes first. It is essential that the **installation** of a P Series narrow motorized unit setup be carried out by **qualified erectors/dismantlers** under the supervision of a **competent person** in accordance with all applicable local regulations.

The use of fall protection is mandatory for erectors/dismantlers during the installation of most sections and tie levels. For the definition of a competent person or a qualified erector/dismantler, refer to p. 7 of the *Performance and Safety Rules* section. For information about fall protection, refer to p. 27 of the *Safety Devices* section.

It is mandatory to make sure that the motorized unit installation remains stable and secure throughout the erection maneuvers.

For each setup and configuration, a job/task-specific installation procedure for any Hydro Mobile equipment used must be compiled in consultation with and approved by a qualified person before proceeding with the installation of the equipment.

General guidelines

- 1- Make sure that all loads have been removed from the motorized unit and that all workers have stepped down before lifting and transporting the motorized unit.
- 2- Make sure all the equipment necessary for a safe erection of the installation is on hand (slings, crane or rough terrain forklift, etc., as required).
- 3- It is important to make sure that **all guardrails required for the configuration are available** as some may not be included with bridges and may have to be purchased separately. For more information about guardrails, refer to p. 50 of the *Accessories* section.
- 4- It is important to make sure that **all outriggers required for the configuration are available** and that they are of a length appropriate for the configuration and space restrictions. It is important to keep in mind that outriggers may also have to be inserted into a bridge before the bridge is installed when space is restricted.
- 5- It is important to note that **only standard configurations** are allowed for P Series narrow motorized unit setups. A standard configuration is a linear installation that does not require the use of angled or non-linear equipment, nor the use of accessories. For more information, refer to the box below.

Definition of a standard configuration

A **standard configuration**, referred to throughout this owner's manual and related documentation, is a linear installation that **does not require** the use of angled or non-linear equipment, such as a forward/rear extension bridge or swivel bridge, nor the use of weather protection, of a hoist support structure or of a planking configuration wider than three planks.

A P narrow motorized unit setup can **only be installed** in a **standard configuration**.

It is **mandatory** to refer to the *Load Capacities* section on p. 47 for the number of bridges allowed in a standard single unit or twin units installation.



NOTICE

It is important to note that **freestanding installations are not allowed** for P Series narrow motorized unit setups.

- 6- **Freestanding installations are not allowed** for P Series narrow motorized unit setups.
- 7- The **maximum width** of planking allowed in front of a P Series narrow motorized unit installation is **three planks**. The standard width of planking is two planks. A P Series narrow motorized unit installation with a 0 or 1-plank configuration will require the use of a narrow mast tie attachment/mast tie combination assembly.
- 8- It is **mandatory** to refer to the *Tie Level Installation Schedule* table on p. 39 of the *Mast and Mast Ties* section **before the installation of any** P Series narrow motorized unit setup.
- 9- The installation of a P Series narrow motorized unit can be achieved using a progressive installation method or through complete pre-installation of tie levels.
It is important to note that **at least two tie levels must be installed from base level before initiating the installation procedure.**

Preparing the area for the installation

- 10- In reference to the job survey/job hazard analysis, the layout plan, the selected configuration and the job/task-specific installation procedure, determine if there are obstacles or hazards, what are the cribbing and tie requirements, and make sure that all the components required are available.

Motorized Unit

Installation of a Setup

Preparing the area for the installation (cont'd)

- 11- Before installing the motorized unit, determine where the cribbing under the jacks will rest. The bearing surface under the cribbing must be level, clear of debris and have the proper bearing capacity (see the *Minimum Bearing Surface Capacities* table, on p. 15). Should the actual bearing capacity be inferior to the values in the table, seek instructions and recommendations from the site engineer. It is important to note that the **jacks on the base** are designed to level the P Series narrow motorized unit, plumb the mast, and support the load.
- 12- In a two-plank configuration, distance from the finished wall must be at least 20" (51 cm) or the number of planks multiplied by the width of one plank, while allowing 6" to 8" (15 to 20 cm) of play. Add an additional 2" (5 cm) if using a toe board. Refer to applicable local regulations to determine play or the maximum allowable distance between the motorized unit, including its accessories, and the face of the work. The maximum width of planking allowed in front of a P Series narrow motorized unit setup is three planks.
- 13- Mark the position of jacks while taking center-to-center distances into account. Base level differences can be compensated for by adjusting the height of the jacks, or by building wood cribbing.
- 14- Lay down the cribbing and make sure it is level on both its front and side axis.

Mandatory instructions for initial installation

- 15- Unload the motorized unit with a rough terrain forklift or a crane. For more information on the lift and transport of a motorized unit, refer to p. 60 of the *Transport, Storage and Maintenance* section.
- 16- Lift and align the motorized unit with the face of the work or the structure. Lower the motorized unit on the bearing surface.
- 17- Verify that the mast is plumb on both its front and side axis. Lift and level the motorized unit using the jacks on the base.
- 18- Install a first tie level between 2' and 4' (0,6 m and 1,2 m) above base level. For instructions on the installation of mast ties, refer to p. 41 of the *Mast and Mast Ties* section.
- 19- Install mast sections until the second tie level is required. For more information about the schedule of installation of tie levels, refer to the *Tie Level Installation Schedule* on p. 39 of the *Mast and Mast Ties* section. For instructions on the installation of a mast section, refer to p. 38 of the *Mast and Mast Ties* section.
The motorized unit **must remain at base level** until at least **two tie levels** have been installed, so other means of access must be used to install the second tie level.
- 20- Install the second tie level.
- 21- Proceed with the following instruction steps for the installation of the motorized unit setup, as the configuration requires.



CAUTION

To avoid equipment damage that could affect worker safety and could lead to serious injury, it is important to follow the tie level installation schedule for the configuration. It is mandatory to refer to the *Tie Level Installation Schedule* table on p. 39 of the *Mast and Mast Ties* section **before** the installation of **any** P Series narrow configuration. It is also mandatory to refer to the *Load Capacities* section on p. 47 for more information about the loads allowed in a configuration.

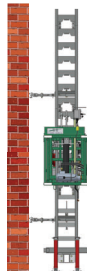

fig. 1.23

At least two tie levels must be installed from base level before initiating installation procedure

Motorized Unit

Installation of a Standard Single Unit Configuration

Installation of the motorized unit

- 1- Prepare the motorized unit and the area where the setup will be installed as described in the guidelines for the installation of a setup, starting on p. 16 of this section. Make sure the motorized unit is installed properly and that at least two tie levels are in place. Make sure the rear platform extension is lifted and secured. For instructions on how to lift and secure the rear platform extension, refer to p. 13 of this section.
- 2- Make sure the inclinometer connection is bypassed. For more information about bypassing the inclinometer connection, refer to p. 24 of the *Safety Devices* section.

Installation of bridges

- 3- Remove the outrigger from any multi-purpose bridge (fig. 1.24) to be used in the installation as the bridge will be bolted by its narrow ends (fig. 1.25).

If space is restricted (see fig. 1.26), make sure all required outriggers are of the proper length for the configuration and space restrictions, and that they are inserted into the bridge **before** it is installed. For instructions on the installation of outriggers, refer to p. 54 of the *Accessories* section.

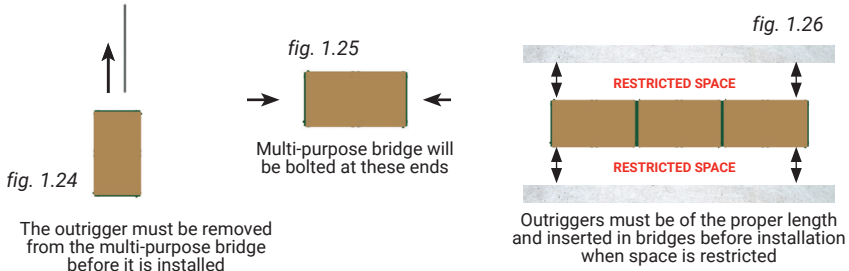

- 4- Using any appropriate lifting device such as a crane or a rough terrain forklift, install as many bridges as is required and allowed. For instructions on the installation of a bridge, refer to p. 29 of the *Bridges* section. Make sure to install bridges alternately, on one side then on the other. Refer to the *Load Capacities* section on p. 47 for the maximum number of bridges allowed in a setup.

Installation of outriggers and planking

- 5- Adjust the outriggers on the bridges, if necessary, and install planks, as required and allowed. For more information about outriggers and planking, refer to p. 54 of the *Accessories* section.

Installation of guardrails

- 6- Before starting to install mast sections, make sure all the required guardrails are in place and secure. In all cases where workers are exposed to fall hazards greater than specified by local regulations, the installation of guardrails or face guardrail supports is **mandatory**. **Guardrails must remain in place throughout erecting operations.** For more information about the installation of guardrails and face guardrail supports, refer to p. 50 of the *Accessories* section.

Installation of mast sections and tie levels

- 7- Using any appropriate lifting equipment such as a crane or a rough terrain forklift, load mast sections on the platform. **Mast sections must be stored horizontally and distributed equally on either side of the mast to ensure good balance.** Refer to the *Load Capacities* section on p. 47 for more information about loading the platform.
- 8- Install mast sections until another tie level is required. Refer to p. 38 of the *Mast and Mast Ties* section for instructions on how to install mast sections. For more information about the schedule of installation of tie levels, refer to the *Tie Level Installation Schedule* on p. 39 of the *Mast and Mast Ties* section. Refer to p. 41 of the *Mast and Mast Ties* section for instructions on how to install mast ties.
- 9- Install as many mast sections as the plan layout requires and as is allowed. A P Series narrow setup must not be used on a mast with a height over 250' (76 m). Make sure throughout the process that the mast remains plumb on both its front and side axis, and that tie levels are installed when required.

Motorized Unit

Installation of a Standard Single Unit Configuration

Installation of mast sections and tie levels (cont'd)

- 10- It is important to make sure to verify the mast bolts when lowering the platform to make sure that they are in good condition and are tightened with the proper torque, especially on **brand-new mast sections**, as the galvanized coating may have compressed. In all cases, mast bolts must be tightened with a torque of 120 lb-ft (163 N-m). Overtightening or undertightening mast bolts may lead to equipment damage.



WARNING

It is important to make sure to verify the mast bolts when lowering the platform to make sure they are in good condition and are tightened with the proper torque, especially on **brand-new mast sections**, as the galvanized coating may have compressed. In all cases, mast bolts must be tightened with a torque of 120 lb-ft (163 N-m). Overtightening or undertightening mast bolts may lead to equipment damage.

Verification of the setup

- 11- Before passing the installation for use and authorizing workers to use the work platform, make a final verification of the setup and perform every step in the daily inspection checklist. If required, fill out the handover sheet to complete the installation. Refer to p. 63 of the *Transport, Storage and Maintenance* section for more information about the daily inspection checklist and to p. 64 for information about the handover sheet.

Installation of additional mast sections and tie levels

- 12- Repeat steps 7 through 11 when it is necessary to install additional mast sections and tie levels. If required, modify the handover sheet accordingly.

Installation of a Standard Twin Units Configuration

(requires the use of two twin mast adapters - type NW – sold separately)

Positioning the first motorized unit

- 1- Prepare the first motorized unit and the area where the setup will be installed as described in the guidelines for the installation of a setup, starting on p. 16 of this section. Make sure the motorized unit is installed properly and that at least two tie levels are in place. Make sure the rear platform extension is lifted and secured. For instructions on how to lift and secure the rear platform extension, refer to p. 13 of this section.

Positioning the second motorized unit

- 2- Determine the position of the second motorized unit while making sure that the required distance is kept between the two motorized units. Refer to the assembly instructions for a bearing bridge structure, on p. 31 of the *Bridges* section.
- 3- Prepare the second motorized unit and the area where it will be installed, as described in the guidelines for the installation of a setup, starting on p. 16 of this section. Make sure the motorized unit is installed properly and that at least two tie levels are in place. Make sure the rear platform extension is lifted and secured. For instructions on how to lift and secure the rear platform extension, refer to p. 13 of this section.

Installation of the bearing bridge structure

- 4- Proceed with the installation of the bearing bridge structure. Refer to p. 31 of the *Bridges* section for more information on the assembly and installation of a bearing bridge.

Make sure all outriggers have been removed from any multi-purpose bridge before the bearing bridge structure is assembled (fig. 1.24, p. 18).

If space is restricted (fig. 1.25, p. 18), make sure all required outriggers are of the proper length for the configuration and space restrictions and that they are inserted into the bridge **before** it is installed. For instructions on the installation of outriggers, refer to p. 54 of the *Accessories* section.

Installation of cantilever bridges

- 5- Proceed with the installation of cantilever bridges on the ends of the motorized units opposite to the bearing bridge structure, as required and allowed. Refer to p. 31 of the *Bridges* section for more information on the installation of a cantilever bridge and to the *Load Capacities* section on p. 47 for the maximum number of bridges allowed in a setup.

Installation of outriggers and planking

- 6- Adjust the outriggers on the bridges, if necessary, and install planks, as required and allowed. For more information about outriggers and planking, refer to p. 54 of the *Accessories* section.

Motorized Unit

Installation of a Standard Twin Units Configuration (requires the use of two twin mast adapters - type NW – sold separately)

Connection and testing of the inclinometers

- 7- Plug in the inclinometers at both ends of the bearing bridge structure. Test the operation of the inclinometers. Refer to p. 24 of the *Safety Devices* section for more information on the installation, use and testing of inclinometers on a bearing bridge structure. If any of the inclinometers is not working properly, the motorized units must be put out of service until the inclinometer has been inspected and repaired by a qualified person. For the definition of a qualified person, refer to p. 7 of the *Performance and Safety Rules* section.

Installation of guardrails

- 8- Before starting to install mast sections, make sure all the required guardrails are in place and secure. In all cases where workers are exposed to fall hazards greater than specified by local regulations, the installation of guardrails or face guardrail supports is **mandatory**. **Guardrails must remain in place throughout erecting operations.** For more information about the installation of guardrails and face guardrail supports, refer to p. 50 of the *Accessories* section.

Installation of mast sections and tie levels

- 9- Using any appropriate lifting equipment such as a crane or a rough terrain forklift, load mast sections on the platform. **Mast sections must be stored horizontally and distributed equally on either side of each mast to ensure good balance.** Refer to the *Load Capacities* section on p. 47 for more information about loading the platform.
- 10- Install mast sections until another tie level is required. Refer to p. 38 of the *Mast and Mast Ties* section for instructions on how to install mast sections. For more information about the schedule of installation of tie levels, refer to the *Tie Level Installation Schedule* on p. 39 of the *Mast and Mast Ties* section. Refer to p. 41 of the *Mast and Mast Ties* section for instructions on how to install mast ties.



CAUTION

When raising or lowering motorized units linked by a bearing bridge, any bridge slope must not exceed a maximum of 2° or 1" / 24" (2,5 cm / 61 cm).

- 11- Install as many mast sections as the plan layout requires and is allowed. A P Series narrow motorized unit setup must not be used on a mast with a height over 250' (76 m). Make sure throughout the process that each mast remains plumb on both its front and side axis, and that tie levels are installed when required.
- 12- It is important to make sure to verify the mast bolts when lowering the platform to make sure that they are in good condition and are tightened with the proper torque, especially on **brand-new mast sections**, as the galvanized coating may have compressed. In all cases, mast bolts must be tightened with a torque of 120 lb-ft (163 N-m). Overtightening or undertightening mast bolts may lead to equipment damage.



WARNING

It is important to make sure to verify the mast bolts when lowering the platform to make sure they are in good condition and are tightened properly, especially on **brand-new mast sections**, as the galvanized coating may have compressed. In all cases, mast bolts must be tightened with a torque of 120 lb-ft (163 N-m). Overtightening or undertightening mast bolts may lead to equipment damage.

Verification of the setup

- 13- Before passing the installation for use and authorizing workers to use the work platform, make a final verification of the setup and perform every step in the daily inspection checklist. If required, fill out the handover sheet to complete the installation. Refer to p. 63 of the *Transport, Storage and Maintenance* section for more information about the daily inspection checklist and to p. 64 for information about the handover sheet.

Installation of additional mast sections and tie levels

- 14- Repeat steps 9 through 13 when it is necessary to install additional mast sections and tie levels. If required, modify the handover sheet accordingly.

Motorized Unit

Dismantling an Installation



SAFETY comes first. It is essential that the **dismantling** of a P Series narrow motorized unit setup be carried out by **qualified erectors/dismantlers** under the supervision of a **competent person** and be performed with the same care and precaution taken during the installation. The use of fall protection is mandatory for erectors/dismantlers during the dismantling of a setup. For the definition of a qualified erector/dismantler or a competent person, refer to p. 7 of the *Performance and Safety Rules* section.

It is mandatory to make sure that the motorized unit installation remains stable and secure throughout the dismantling maneuvers.

For each setup and configuration, a job/task-specific dismantling procedure for any Hydro Mobile equipment used must be compiled in consultation with and approved by a qualified person before proceeding with the dismantling of the equipment.

Safety guidelines for dismantling a motorized unit installation

- 1- Make sure all loads have been removed from the platform.
- 2- Make sure all the equipment necessary for a safe dismantling of the installation is on hand (slings, crane or rough terrain forklift, etc., as required).

Preparing the installation for dismantling

- 1- In reference to the job survey/job hazard analysis, the layout plan, the configuration and the job/task-specific dismantling procedure, determine if there are obstacles or hazards, and make sure the required cribbing is in place and in good condition.
- 2- Inspect all safety devices (safety hooks, emergency descent, inclinometers if the installation is a bearing bridge configuration, etc.) and make sure they are working properly.
- 3- **Make sure the last two (lower) tie levels remain in place until the end of the dismantling operations.**
- 4- Perform every step in the daily inspection checklist on each motorized unit of the setup. Refer to p. 63 of the *Transport, Storage and Maintenance* section for more information about the daily inspection checklist.
- 5- Make sure all necessary guardrails are in place. **Guardrails must remain in place and secure throughout dismantling operations.**
- 6- Bring the motorized unit(s) to the top of the work, verifying mast bolts and mast ties on the way up. Make sure that all mast bolts are tightened with the appropriate torque and that mast ties are properly tied to the face of the work.

Dismantling a Standard Single Unit Installation

Preparing the installation

- 1- Prepare the installation as described in the safety guidelines and the preparation instructions above.
- 2- Make sure the motorized unit is at the top of the work.

Removal of mast sections and tie levels

- 3- Lower the motorized unit to base level, removing mast sections and tie levels on the way down, **leaving the last two tie levels in place.** For instructions on the removal of mast sections, refer to p. 38 of the *Mast and Mast Ties* section. Refer to p. 42 of the *Mast and Mast Ties* section for instructions on the removal of tie levels.

Mast sections loaded on the platform during dismantling must be stored horizontally and distributed equally on either side of the mast to ensure good balance.

Make sure to avoid overloading the platform. On higher installations, it may be required to use a crane to remove mast sections from the platform to avoid any overloads. Refer to the *Load Capacities* section on p. 47 for more information about loads allowed on an installation.



CAUTION

The last two (lower) tie levels must be left in place on each motorized unit **until the end of the dismantling operations.**

Removing planking and guardrails

- 4- With the last two tie levels still in place, bring the motorized unit to base level, remove all loads from the platform and make all workers step down.

Motorized Unit

Dismantling a Standard Single Unit Installation

Removing planking and guardrails (cont'd)

- 1- Remove the planking and the guardrails. Store the guardrails properly. For instructions on how to store guardrails, refer to p. 58 of the *Transport, Storage and Maintenance* section. If possible, push in all outriggers and secure in place.

Removing the cantilever bridges

- 2- Remove all installed cantilever bridges. To ensure balance, remove bridges alternately, from one side then the other. Push in and secure all outriggers. Store the bridges properly. For instructions on how to store a bridge, refer to p. 58 of the *Transport, Storage and Maintenance* section.

Removing the last two tie levels and completing the dismantling

- 3- Bring the motorized unit down to base level.
- 4- Make sure the motorized unit is stable and remove the next-to-last tie level.
The motorized unit must remain at base level, other means must be used to remove tie levels and mast sections.
- 5- With the help of a crane or any other appropriate lifting device, remove all mast sections installed above the last tie level. To facilitate the removal of those mast sections, it is recommended to remove them assembled together and to handle them with the optional multiple mast handler. For instructions on the use of the optional multiple mast handler, refer to p. 54 of the *Accessories* section.
- 6- Make sure the motorized unit is stable and proceed with the removal of the last tie level.
- 7- If the unit is to be stored for any significant length of time, refer to p. 59 of the *Transport, Storage and Maintenance* section for instructions on how to properly store a P Series narrow motorized unit.

Dismantling a Standard Twin Units Installation

Preparing the installation

- 1- Prepare the installation as described in the safety guidelines and the preparation instructions on p. 21.
- 2- Make sure the motorized units are at the top of the work.

Removal of mast sections and tie levels

- 3- Lower the twin motorized units linked by a bearing bridge down to base level, removing mast sections and tie levels on the way down, **leaving the last two tie levels in place**. For instructions on the removal of mast sections, refer to p. 38 of the *Mast and Mast Ties* section. Refer to p. 42 of the *Mast and Mast Ties* section for instructions on the removal of tie levels.

To make sure the installation remains stable, remove mast sections and tie levels alternately – one section or tie level on one motorized unit, then on the other. Mast sections loaded on the platform during dismantling must be stored horizontally and distributed equally on either side of each mast to ensure good balance.

Make sure to avoid overloading the platform. On higher installations, it may be required to use a crane to remove mast sections from the platform to avoid any overloads. Refer to p. 47 of the *Load Capacities* section for more information about loads allowed on an installation.



CAUTION

When raising or lowering motorized units linked by a bearing bridge, any bridge slope must not to exceed a maximum of 2° or 1" / 24" (2,5 cm / 61 cm).



CAUTION

Two tie levels must be left in place on each motorized unit until the **end of the dismantling operations**.

Motorized Unit

Dismantling a Standard Twin Units Installation

Removing planking and guardrails

- 4- With the last two tie levels still in place, bring the motorized units to base level, remove all loads from the platform and make all workers step down.
- 5- Remove the planking and the guardrails. Store the guardrails properly. For instructions on how to store guardrails, refer to p. 58 of the *Transport, Storage and Maintenance* section. If possible, push in all outriggers and secure in place.

Removing the cantilever bridges

- 6- First remove all installed cantilever bridges. Push in and secure all outriggers. Store the bridges properly. For instructions on how to store a bridge, refer to p. 58 of the *Transport, Storage and Maintenance* section.

Removing the bearing bridge structure

- 7- Disconnect both inclinometers. For instructions on the disconnection of an inclinometer, refer to p. 24 of the *Safety Devices* section.
- 8- Proceed with the dismantling of the bearing bridge structure. For instructions on the dismantling of a bearing bridge structure, refer to p. 32 of the *Bridges* section.

Removing the last two tie levels and completing the dismantling

- 9- Make sure the motorized units are stable and remove the next-to-last tie level on each motorized unit.
The motorized units must remain at base level, other means must be used to remove tie levels and mast sections.
- 10- With the help of a crane or any other appropriate lifting device, remove all mast sections installed above the last tie level on each motorized unit. To facilitate the removal of those mast sections, it is recommended to remove them assembled together and to handle them with the optional multiple mast handler. For instructions on the use of the optional multiple mast handler, refer to p. 54 of the *Accessories* section.
- 11- Make sure each motorized unit is stable and proceed with the removal of the last tie level on both motorized unit.
- 12- If any of the units is to be stored for any significant length of time, refer to p. 59 of the *Transport, Storage and Maintenance* section for instructions on how to properly store a P Series narrow motorized unit.

Safety Devices

Inclinometer (Leveling Control Device)

Used only in twin units configurations, the inclinometer is located on the narrow twin mast adapter (fig. 2.3 and fig. 2.4) and must **absolutely** be linked to the electrical system of the motorized unit through its main electrical power supply box (fig. 2.5).

Each inclinometer of a twin units configuration will detect any ± 2 -degree slope of the structure and stop the motorized unit it is linked to until the structure is level again. For instructions on the installation and use of a twin mast adapter for narrow setups, refer to p. 30 of the *Bridges* section.

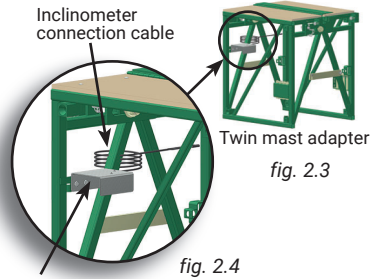
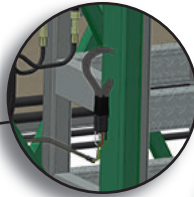
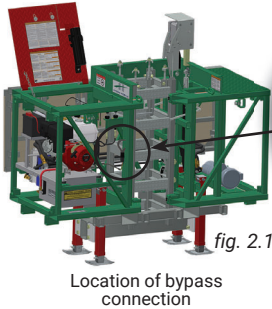

Location of inclinometer

fig. 2.4



Connection for inclinometer cable

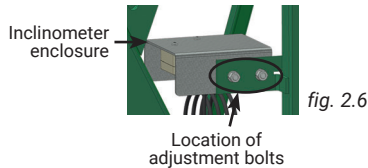

Connecting and resetting the inclinometers

- 1- Make sure the bearing bridge structure is level.
- 2- Locate the bypass connection (loop) on the structure of the motorized unit (fig. 2.1).
- 3- Disconnect the bypass connection and plug in the inclinometer connection cable (fig. 2.5).
- 4- Place a torpedo level on top of the inclinometer enclosure. Verify the level of the inclinometer.
- 5- Loosen one of the adjustment bolts (fig. 2.6) and raise or lower the enclosure until the inclinometer is set at a 0° level. Tighten the bolt.
- 6- Repeat steps 2 to 4 for the inclinometer at the other end of the bearing bridge structure.
- 7- If any of the inclinometers cannot be adjusted to a 0° level, the motorized units must be put out of service until the installation has been inspected and the issue has been corrected by a qualified person. For the definition of qualified person, refer to p. 7 of the *Performance and Safety Rules* section.
- 8- Make sure to test both inclinometers before operating the motorized units.



CAUTION

When raising or lowering motorized units linked by a bearing bridge, any bridge slope must not to exceed a maximum of 2° or $1^\circ / 24''$ (2,5 cm / 61 cm).

Safety Devices

Inclinometer (Leveling Control Device)

Testing the inclinometers

- 1- Make sure the bearing bridge structure is level and that both inclinometers are connected properly.
- 2- Raise one end of the bearing bridge structure. If the inclinometers are working properly, both units stop moving when a slope of the structure is detected and the lower motorized unit cannot be lowered. Bring the structure back to level, following the instructions further on.
- 3- Repeat step 2 at the other end of the bearing bridge structure. Bring the structure back to level.
- 4- Raise the bearing bridge structure until it is at least 10' (3 m) above base level. Make sure the bearing bridge structure is level.
- 5- Lower one end of the bearing bridge structure. If the inclinometers are working properly, both units stop moving when a slope of the structure is detected and the higher motorized unit cannot be raised. Bring the structure back to level.
- 6- Repeat step 5 at the other end of the bearing bridge structure. Bring the structure back to level.
- 7- If any of the inclinometers is not working properly, the motorized units must be put out of service until the inclinometer has been inspected and repaired by a qualified person. For the definition of a qualified person, refer to p. 7 of the *Performance and Safety Rules* section.

Bringing the structure back to level

- 1- When the motorized units are moving, if a slope of ± 2 degrees of the bearing bridge structure is detected (fig. 2.7), the power supply of the solenoid valves is shut off. Both motorized units stop moving but the engines are still running.
- 2- To bring the bearing bridge structure back to level and resume operation, bypass the inclinometer signal **on the lowest motorized unit of the installation** by pushing in and holding the inclinometer bypass button on the joystick control box (fig. 2.8) and raising the motorized unit until the setup is level again. Always bypass the signal on the lowest unit on the installation and raise that unit, whether the platform is being raised or lowered.
- 3- Make sure that the bearing bridge structure is level before resuming operation. Repeat step 2, if necessary.

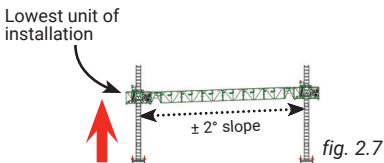

Inclinometer signal must be bypassed on the **lowest motorized unit** and that unit must be raised – whether the platform is being raised or lowered

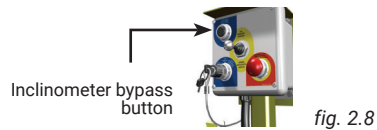

CAUTION

Always bypass the signal on the **lowest motorized unit of the installation** and raise that unit, whether the platform is being raised or lowered.



CAUTION

Daily verification and testing of all the inclinometers are **mandatory before operating** the motorized units.

Safety Devices

Safety Hooks System

Activation of the safety hooks system

In the event of an activation of the safety hooks system, the qualified operator must contact the competent person. For the definition of a qualified operator or a competent person, refer to p. 7 of the *Performance and Safety Rules* section.

All precautions must be immediately taken to ensure the safe return of all workers to the nearest safe evacuation point according to the evacuation plan (see step 21, p. 8 of the *Performance and Safety Rules* section). **The motorized unit must be immediately put out of service.**

The following steps must be performed by an authorized technician. For the definition of an authorized technician, refer to p. 7 of the *Performance and Safety Rules* section. Seek advice from the distributor/service center or the Hydro Mobile technical team, if required.

- 1- Make sure that the safety hooks system is properly engaged (fig. 2.10) and that the motorized unit is stable and secure.
- 2- Determine what caused the activation of the safety hooks system.
- 3- Remove as much load from the motorized unit and the bridges as possible.
- 4- Perform a thorough inspection of the entire installation from base level to the top of the work, including structures, mast ties, anchoring system for any damages possibly caused by the incident.
- 5- Take the necessary actions to have the motorized unit repaired properly, according to Hydro Mobile standards. It is **mandatory** to visually inspect the safety hooks and replace the hook that was activated. Any **triggered** safety hook **cannot be used a second time and must be replaced immediately** before operating the motorized unit. It is also **mandatory** to replace the bolt and nut of the safety hook.
- 6- Once all the mandatory corrective actions described in the previous steps have been carried out, make sure that the cylinder hook and the secondary hook are properly engaged on a mast rung (see fig. 2.12 and fig. 2.13) and **carefully lower** the motorized unit to base level.
- 7- In all cases, the motorized unit must be thoroughly inspected and all the necessary repairs must be made according to Hydro Mobile's recommendations before resuming normal operation of the motorized unit.

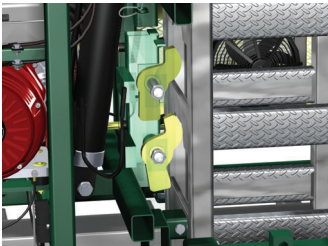

Safety hooks in normal working position fig. 2.9

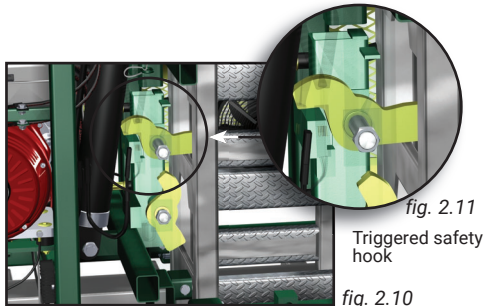

Safety hooks in emergency activation position fig. 2.10



fig. 2.12

Correct



fig. 2.13

Incorrect

Safety Devices

Fall Protection

The use of fall protection equipment is **mandatory** for erectors/dismantlers during the installation and removal of mast sections and tie levels, or for workers modifying a planking configuration or moving planks when passing a tie level. The use of fall protection is also **mandatory** for all workers on a P Series narrow motorized unit setup whenever a fall hazard is present.

It is recommended to use a combination of full body harness and a shock-absorbing lanyard. It is mandatory to use certified fall protection equipment that is clean and in good working condition. Fall protection equipment must be inspected before each use and be replaced if found or suspected to be defective.

Refer to the manufacturer's recommendations for more information about the use and care of the selected equipment. Refer also to local regulations for more information about fall protection equipment requirements.

- 1- Using the designated tie points (fig. 2.14) on the motorized unit, an optional fall arrest bracket installed on two guardrails (fig. 2.16) or a cross-arm anchorage strap tied to two guardrails (fig. 2.17), secure the fall protection equipment.

Tie points are designed to resist to a maximum arrest force of 5000 lb (2268 kg) and can be used by workers to tie themselves to the unit (not more than one worker per tie point).

Only 30" (76 cm), 33" (84 cm) or 60" (1,6 m) **standard guardrails** can be used as tie points; it is prohibited to use a twin mast adapter guardrail, a swivel bridge guardrail, a door guardrail, a movable guardrail, a plank-end guardrail or a face guardrail bracket as a tie point. It is mandatory to make sure that the guardrail used as a tie point is properly fastened.

- 2- Install a mast section, install a tie level, move planks in front of the mast to pass a tie level or modify the planking configuration.

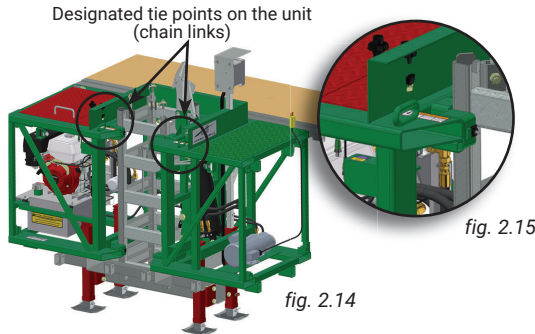

Not more than one worker per tie point (chain link)

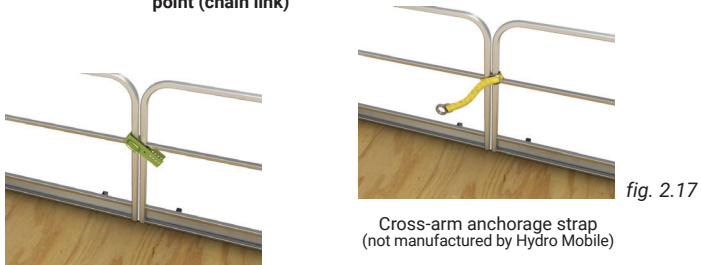

Fall arrest bracket

Cross-arm anchorage strap (not manufactured by Hydro Mobile)

Safety Devices

Emergency Descent Control Device

In the event of an engine failure or a shortage of gasoline, it is recommended to use the emergency descent control device to bring the workers and the motorized unit safely to the **nearest safe evacuation point** according to the evacuation plan (see step 21, p. 8 of the *Performance and Safety Rules* section). The emergency descent control device (120 V in North America; 240 V in Europe) is standard only on specific P Series motorized units. It is important to note that the emergency descent control device **must not be used** if the failure is due to a malfunction of the cylinder, a malfunction of one or both hooks, or a leak in the hydraulic system.



CAUTION

Emergency descent control devices are designed for emergencies only. These devices must not be used to operate the motorized unit **under normal conditions**.

Emergency descent procedure

- 1- Before initiating the descent, make sure that the motorized unit and plank outriggers clear mast ties, the building, balconies, etc.
- 2- Unlock the lowering cam on both the cylinder hook and the secondary hook (fig. 2.21).
- 3- Locate the power cord for the emergency descent motor located inside the storage area for the control post (fig. 2.18). Connect the power cord of the emergency descent motor into an appropriate, reliable power source, using an extension cord, if necessary. The emergency motor will start immediately once it is plugged into the power source.
- 4- Open the engine access panel and locate the override buttons on top of the hydraulic block (fig. 2.19). Since the control lever cannot be used to control the motorized unit when using the emergency motor, the override buttons must be used to move the motorized unit.

Engine access panel Location of power cable plug

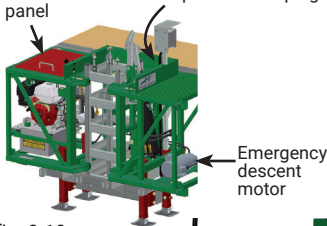

fig. 2.18

Location of override buttons

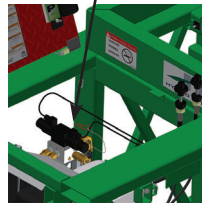
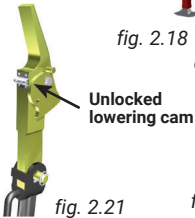

fig. 2.19

Emergency descent motor



Unlocked lowering cam

fig. 2.21

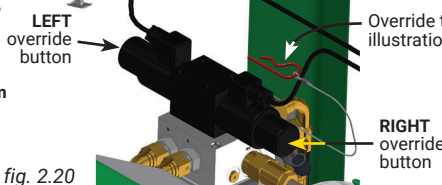

LEFT override button

fig. 2.20

Override tool (in red for illustration purposes only)

RIGHT override button

- 5- Perform the necessary steps to lower or raise the motorized unit to the nearest safe evacuation point, using the override buttons instead of the control lever, where the **LEFT** button will act as bringing the control lever **DOWN** (extend the cylinder), while the **RIGHT** button will act as bringing the control lever **UP** (retract the cylinder). Refer to p. 34 and p. 36 of the *Power Pack and Operating Components* section for instructions on raising and lowering the motorized unit.

Action on override button	Correspondence on control lever
Press and hold LEFT override button	Lower the control lever
Press and hold RIGHT override button	Raise the control lever

- 6- If the nearest safe evacuation point is at base level, monitor the last 10' (or 3 m) of descent to ensure the proper seating of the access stairs, if necessary.



CAUTION

It is important to note that the emergency descent control device **must not be used** if the failure is due to a malfunction of the cylinder, a malfunction of one or both hooks, or a leak in the hydraulic system.

Bridges

Bridge Types

Multi-Purpose Bridge



fig. 3.1

Dimensions	33 1/4" x 62 1/4" x 35 13/16" (84,5 cm x 158 cm x 91 cm)
Weight	310 lb (141 kg)
Guardrail	1x 33" (84 cm) ¹ 42 lb (19 kg) (including adapters)
Outrigger	1x 2 1/2" x 1 1/2" x 1/8" x 63" long (6,4 cm x 3,8 cm x 0,3 cm x 160 cm)
Bolt and nut sets	4x 5/8" x 4 1/2" long (GR8 UNC) 6x 5/8" x 5 1/2" long

¹ An optional 60" (152 cm) guardrail will be required

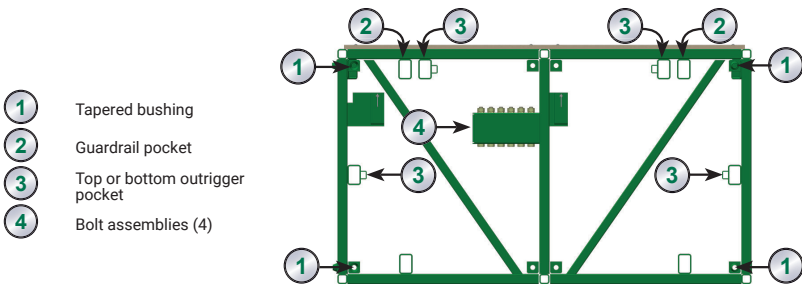

fig. 3.2

- ① Tapered bushing
- ② Guardrail pocket
- ③ Top or bottom outrigger pocket
- ④ Bolt assemblies (4)



NOTICE

It is **important** to note that each multi-purpose bridge used on the installation will require an optional 60" (152 cm) guardrail, as the bridge is installed laterally in narrow setups.



Installation

- 1- Align the tapered bushings ("1" in fig. 3.2) of the multi-purpose bridge with the motorized unit, the bridge or the narrow twin mast adapter.
- 2- Bolt the multi-purpose bridge to the motorized unit, the bridge or the narrow twin mast adapter using a 5/8" x 4 1/2" (GR8) bolt assembly in each of the four corner tapered bushings. Tighten all bolt assemblies with a torque of 120 lb-ft (163 N-m).
- 3- Install cantilever multi-purpose bridges alternately on each side of the mast in such a sequence as to warrant the balance of the structure.

Bridges

Bridge Types

Multi-Purpose Cubic Bridge

fig. 3.5

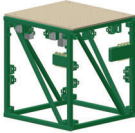

Dimensions	33 7/8" x 33 1/2" x 35 13/16" (86 cm x 85 cm x 91 cm)
Weight	155 lb (70 kg)
Bolt and nut sets	4x 5/8" x 4 1/2" long (GR8 UNC) 4x 5/8" x 5 1/2" long



NOTICE

It is **important** to note that each multi-purpose bridge used on the installation will require an optional 30" (76 cm) guardrail, as there is no guardrail included with the multi-purpose cubic bridge.

Installation

- 1- Align the tapered bushings ("1" in fig. 3.2, p. 29) of the multi-purpose cubic bridge with the motorized unit, the bridge or the narrow twin mast adapter.
- 2- Bolt the multi-purpose bridge to the motorized unit, the bridge or the narrow twin mast adapter using a 5/8" x 4 1/2" (GR8) bolt assembly in each of the four corner tapered bushings. Tighten all bolt assemblies with a torque of 120 lb-ft (163 N-m).
- 3- Install cantilever multi-purpose bridges alternately on each side of the mast in such a sequence as to warrant the balance of the structure.

Twin Mast Adapter – type NW (required for a bearing bridge configuration)

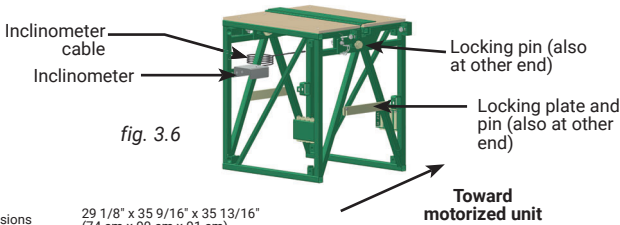

fig. 3.6

Dimensions	29 1/8" x 35 9/16" x 35 13/16" (74 cm x 90 cm x 91 cm)
Weight	210 lb (109 kg)
Accessory	Inclinometer
Bolt and nut sets	4x 5/8" x 5 1/2" long (GR8 UNC) 4x 5/8" x 4 1/2" long (GR8 UNC)

Installation

- 1- Position the NW twin mast adapter so that the inclinometer is located on the **bearing bridge side** of the structure, opposite to the motorized unit. Refer to the instructions on the assembly of a bearing bridge structure further on in this section.
- 2- Align and bolt the NW twin mast adapter to the last multi-purpose bridge at one end of the bearing bridge structure, using a 5/8" x 4 1/2" (GR8) bolt assembly in each of the four corner tapered bushings. Tighten all bolt assemblies with a torque of 120 lb-ft (163 N-m).
- 3- Repeat steps 1 and 2 above to install the second NW twin mast adapter at the other end of the bearing bridge structure. **The locking pins and plates must not be unhooked or unlocked at this point.**

Bridges

Cantilever Bridge

Installation

- 1- Bolt a multi-purpose bridge assembly to the motorized unit on one side of the mast. Refer to p. 29 of this section for instructions on the installation of a multi-purpose bridge and to p. 30 for the instructions on the installation of a cubic bridge.
- 2- Repeat step 1 for each multi-purpose bridge to install.
- 3- Refer to the installation instructions appropriate to the configuration, starting on p. 16.
- 4- Install as many additional bridges as required and allowed. Refer to p. 47 of the *Load Capacities* section for information about the number of bridges allowed in a cantilever bridge configuration.

In a single unit configuration, it is important to install each bridge alternately on one side, then on the other side of the mast, to avoid throwing the structure out of balance. The number of bridges must be equal on both sides of the mast in a single unit configuration.

Bearing Bridge

(requires the use of two motorized units and two twin mast adapters (type NW) – sold separately)

Safety guidelines

- 1- In a twin units setup, it is mandatory to install any additional cantilever bridge **after** the bearing bridge structure has been installed to avoid throwing the structure off balance. Components of the structure must be dismantled in reverse order.
- 2- It is **mandatory** that two qualified users/operators handle all rise and descent operations and coordinate the motion of the two motorized units linked by a bearing bridge to ensure that the structure slope does not exceed 2° or $1'' / 24''$ (2,5 cm / 61 cm) as shown in fig. 2.7, p. 25 of the *Safety Devices* section. For the definition of a qualified user/operator, refer to p. 7 of the *Performance and Safety Rules* section.
- 3- Daily verification and testing of all the inclinometers are **mandatory before** operating the motorized units.

Assembly of a bearing bridge structure

- 1- Choose a clear, level surface close to the work area where the bridges can be temporarily set down to assemble the bearing bridge structure. To facilitate assembly, set down wood cribbing or mast sections laid horizontally before lowering the bridges in place.
- 2- The bearing bridge structure must **only** be composed of multi-purpose and cubic bridges.
- 3- Using a rough terrain forklift or a crane, lift and lower a bridge on top of the wood cribbing or the laid down mast sections.
- 4- Lift another bridge and align it carefully with the bridge it must be attached to. Assemble the two bridges together. Refer to p. 29 of this section for instructions on the installation of a multi-purpose bridge and to p. 30 for the instructions on the installation of a multi-purpose cubic bridge.

Bridges

Bearing Bridge

Assembly of a bearing bridge structure (cont'd)

- 1- Complete the assembly of the bearing bridge structure using as many bridges as is required and allowed. Refer to p. 49 of the *Load Capacities* section for information on the number of bridges allowed in a bearing bridge configuration.
- 2- Install an NW twin mast adapter at each end of the bearing bridge structure. For instructions on the installation of an NW twin mast adapter, refer to p. 30 of this section. **The locking pins and plates must not be unhooked or unlocked at this point.**

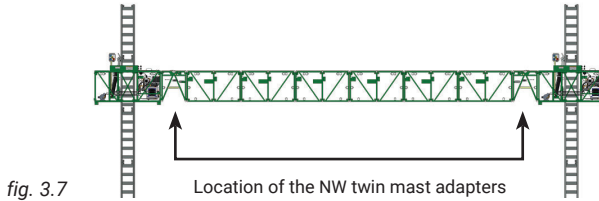

Installation of a bearing bridge structure

- 1- Using an appropriate lifting device such as a rough terrain forklift or a crane, carefully lift the bearing bridge structure and lower it into position, between the two motorized units installed. Refer to p. 19 of the *Motorized Unit* section for instructions on the installation of two motorized units linked by a bearing bridge.
- 2- Bolt each NW twin mast adapter to the motorized unit using a 5/8" x 5 1/2" (GR8) bolt assembly in each of the four corner tapered bushings. Tighten all bolt assemblies with a torque of 120 lb-ft (163 N-m). **Make sure to unlock the locking pins and unhook the plates on each NW twin mast adapter.**
- 3- Make sure that both inclinometers are properly connected. For more information about inclinometers, see p. 24 of the *Safety Devices* section.
- 4- It is **mandatory** that two qualified users/operators handle all rise and descent operations and coordinate the motion of the two motorized units linked by a bearing bridge to ensure that the structure slope does not exceed 2° or 1" / 24" (2,5 cm / 61 cm) as shown in fig. 2.7, p. 25 of the *Safety Devices* section. For the definition of a qualified user/operator, refer to p. 7 of the *Performance and Safety Rules* section.



NOTICE

It is **mandatory** that two qualified users/operators handle all rise and descent operations and coordinate the motion of the two motorized units linked by a bearing bridge to ensure that the structure slope does not exceed 2° or 1" / 24" (2,5 cm / 61 cm) as shown in fig. 2.7, p. 25 of the *Safety Devices* section. For the definition of a qualified user/operator, refer to p. 7 of the *Performance and Safety Rules* section.

Dismantling a bearing bridge structure

- 1- Refer to the safety guidelines for dismantling an installation, on p. 21 of the *Motorized Unit* section.
- 2- Make sure the bearing bridge structure is at base level.
- 3- Make sure that all cantilever bridges have been removed.
- 4- Completely unload the work platform and make workers step down off the structure.
- 5- Make sure both inclinometers have been disconnected.
- 6- Replace the locking pins and plates on each NW twin mast adapter.
- 7- Using an appropriate lifting device such as a rough terrain forklift or a crane, support the bearing bridge structure. Unbolt the NW twin mast adapters from the motorized units.
- 8- Slightly raise the bearing bridge structure and lower it on the ground to dismantle it.
- 9- Store all bearing bridge components properly. For instructions on the storage of a twin mast adapter or a bridge, refer to p. 58 of the *Transport, Storage and Maintenance* section.

Power Pack and Operating Components

Startup preparation instructions

- 1- Pull the spring latch (fig. 4.2) and pull the control post completely out of its storage position.
- 2- Rotate the control post to 90° so that controls are facing the rear platform extension.
- 3- Pull the spring latch again and let the control post slide down until the spring latch is engaged and locks the control post in place.
- 4- If the motorized unit is brand-new or has been stored for a significant length of time, connect the battery.

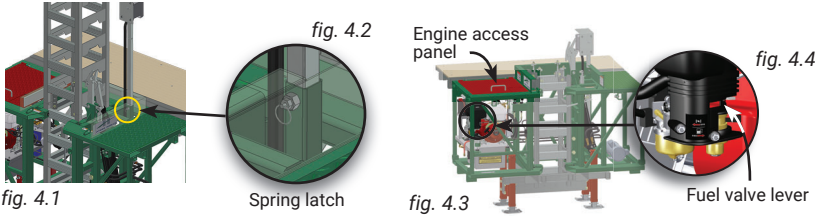

- 5- Perform every step in the daily inspection checklist. Refer to p. 63 of the *Transport, Storage and Maintenance* section for more information about the daily inspection checklist.
- 6- Move the engine gasoline valve lever to the ON position.

Engine and motorized unit startup procedure

- 1- Make sure the rear platform extension is lifted before starting the engine.
- 2- CLOSING THE CHOKE: If the engine is cold, push in and hold the button to push in the choke cable to the closed position (blue control cable, fig. 4.6). Adjust by rotating the knob, if necessary. If the engine is warm, leave the choke cable at the open position (pulled out).
- 3- USING THE THROTTLE: Push in and hold the button to push in the throttle cable halfway to three quarters of the way (yellow control cable, fig. 4.6). Adjust by rotating the knob, if necessary.
- 4- Pull out the emergency stop button (fig. 4.7).
- 5- Turn and hold the ignition key at the START position (fig. 4.7) to start the engine (hold for a maximum of 10 seconds). Release the key as soon as the engine is running. Use the ignition key to shut down the engine.
- 6- OPENING THE CHOKE: Push in and hold the button, then slowly pull out the choke cable all the way to the open position.
- 7- To adjust the engine speed, push in and hold the button, then push in the throttle cable all the way to reach maximum RPM. Adjust by rotating the knob, if necessary.

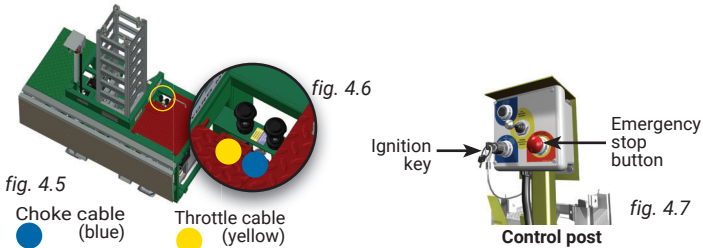

Engine and motorized unit shutdown procedure

- 1- THROTTLING DOWN: Before shutting down the engine, push in and hold the button to pull out the throttle cable all the way (yellow control cable, fig. 4.6).
- 2- To shut down the engine, turn the ignition key to the OFF position or push in the emergency stop button (fig. 4.7).

Power Pack and Operating Components

SAFETY comes first. The raising and lowering of the platform must be visually monitored at all times. It is mandatory to make sure that **both** hooks are properly engaged on a mast rung before and after raising or lowering the platform. Failure to engage the hooks correctly may cause the platform to drop, leading to damages to equipment and injury, even death.

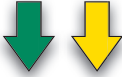
	<p>RAISING the control lever will cause the cylinder to retract and generate an upward motion of the platform</p> <p>GREEN ARROW indicates to raise and hold the control lever until the cylinder retracts completely</p> <p>YELLOW ARROW indicates to raise and hold the control lever until the cylinder has retracted sufficiently for the task to perform</p>
	<p>LOWERING the control lever will cause the cylinder to extend and generate a downward motion of the platform</p> <p>GREEN ARROW indicates to lower and hold the control lever until the cylinder extends completely</p> <p>YELLOW ARROW indicates to lower and hold the control lever until the cylinder has extended sufficiently for the task to perform</p>

Raising the platform

1- Before initiating the ascent, make sure that the motorized unit and plank outriggers clear the building, balconies, etc., and that planking has been removed from in front of the mast when passing a tie level.

2- Lock the lowering cam on both the cylinder hook and the secondary hook (fig. 4.8).

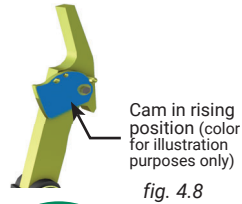

3- Make sure that the engine is running at full throttle and that the cylinder hook and the secondary hook are properly engaged (fig. 4.9 and fig. 4.10) and on the same mast rung (fig. 4.13, p. 35). Failure to engage the hooks correctly can cause the platform to drop.

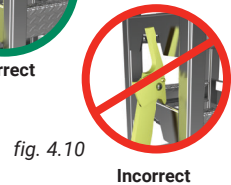
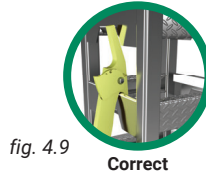

CAUTION

Make sure the cylinder hook and the secondary hook are properly engaged (fig. 4.9 and fig. 4.10) and on the same mast rung (fig. 4.13, p. 35) before and after raising or lowering platform. Failure to engage hooks correctly can cause the platform to drop.

Power Pack and Operating Components

Raising the platform

- 4- Lower the control lever and extend the hydraulic cylinder (to reach the second-to-next rung) (fig. 4.12). The engine will slow down if the cylinder is fully extended.



Reach the second-to-next rung

fig. 4.12

- 5- Raise the control lever so the cylinder hook drops slightly, enough to engage onto the mast rung. Before raising the platform, check visually to make sure that the cylinder hook is properly engaged on the mast rung.



fig. 4.11

- 6- Raise the control lever and let the platform rise until the secondary hook is above the rung where the cylinder hook is engaged. The lift can vary from one to two mast rungs.

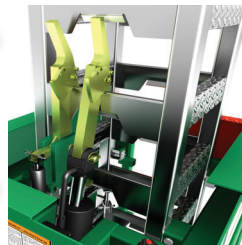

fig. 4.13

- 7- Lower the control lever enough to engage the secondary hook on the mast rung. Both hooks will now be side by side on the same mast rung. The platform will lower slightly at this stage.



- 8- Repeat steps 4 through 7 to continue raising the platform.

- 9- Once the platform has reached the desired height, make sure that both hooks are properly engaged on the same mast rung.

**CAUTION**

In a twin units configuration, it is mandatory to coordinate the rise and descent operation on each motorized unit linked by the bearing bridge to ensure that any slope of the structure does not exceed 2 degrees.

**WARNING**

The use of fall protection equipment is **mandatory** to handle operations when passing tie levels. Properly tied to the unit, slide planks away from in front of the mast. The use of shorter planks will facilitate this task.

Power Pack and Operating Components

Lowering the platform

1- Before initiating descent, make sure that the motorized unit and plank outriggers clear the building, balconies, etc., and that planking has been removed from in front of the mast when passing a tie level.

2- Unlock the lowering cam on both the cylinder hook and the secondary hook (fig. 4.14).

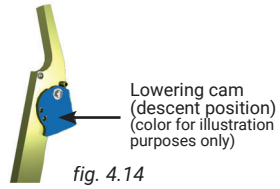

3- Make sure that the engine is running at full throttle and that the cylinder hook and the secondary hook are properly engaged (fig. 4.15 and fig. 4.16) and on the same mast rung (fig. 4.21, p. 37). Failure to engage the hooks correctly can cause the platform to drop.

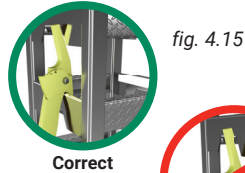
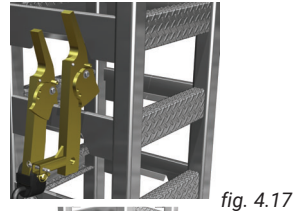
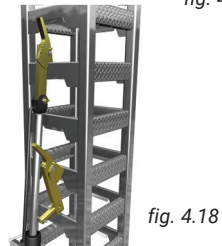

fig. 4.16

4- Raise the control lever to retract the cylinder completely so the lowering cam of the secondary hook can swing toward the mast. The engine will slow down when the cylinder has retracted completely. At this stage, the platform will rise slightly.



5- Lower the control lever and extend the hydraulic cylinder. The platform will lower by one to two mast rungs (fig. 4.18). The engine will slow down if the cylinder is fully extended.



CAUTION

In a twin units configuration, it is mandatory to coordinate the rise and descent operation on each motorized unit linked by the bearing bridge to ensure that any slope of the structure does not exceed 2 degrees.

Power Pack and Operating Components

Lowering the platform (cont'd)

- 6- Raise the control lever so the cylinder retracts itself enough so the secondary hook is above the mast rung (but not its lowering cam). At this stage the platform will rise slightly.



fig. 4.19

- 7- Lower the control lever so the secondary hook drops slightly, enough to engage onto the mast rung. At this stage, the platform will lower slightly.



Before lowering the platform, check visually to make sure that the secondary hook is properly engaged on the mast rung.

- 8- Lower the control lever again to extend the cylinder completely and force its lowering cam to swing toward the mast.



fig. 4.20

- 9- Raise the control lever so the cylinder retracts completely.



- 10- Lower the control lever to extend the cylinder enough until its hook is above the mast rung (but not its lowering cam).

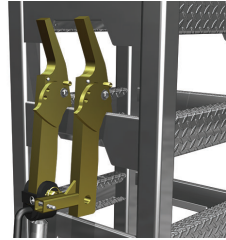

fig. 4.21

- 11- Raise the control lever so the cylinder hook drops slightly, enough to engage onto the mast rung.



Both the cylinder and secondary hooks will be side by side on the same mast rung.

- 12- Repeat steps 4 through 11 to continue lowering the platform.

- 13- Monitor the last 10' (3 m) of descent to base level to ensure proper clearance under and around the lowering platform.

- 14- Once the platform has been brought down to base level or to the desired height, make sure that both hooks are properly engaged on the same mast rung.

**WARNING**

The use of fall protection equipment is **mandatory** to handle operations when passing tie levels. Properly tied to the unit, slide planks away from in front of the mast. The use of shorter planks will facilitate this task.

**CAUTION**

Make sure the cylinder hook and the secondary hook are properly engaged (fig. 4.15 and fig. 4.16, p. 36) and on the same mast rung (fig. 4.21) before and after raising or lowering platform. Failure to engage hooks correctly can cause the platform to drop.

Mast and Mast Ties

Mast Sections

The installation and removal of mast sections must be performed with care to avoid any twisting of the mast that may compromise the proper operation of the motorized unit setup and lead to safety issues.

The front face of mast sections must always be parallel to the face of the work. It is important to verify that the mast remains parallel throughout the installation of mast sections.

Mast sections loaded on the platform using a crane or a rough terrain forklift **must be stored horizontally and distributed equally on either side of the mast to ensure good balance**. Refer to the *Load Capacities* section on p. 47 for more information about loading the platform.

Installation of a single mast section

- 1- Make sure that the motorized unit is positioned properly. Refer to guidelines and instructions, starting on p. 16 of the *Motorized Unit* section for more information. Refer to applicable local regulations governing distances between the mast climbing work platform system and electrical lines.
- 2- Bring the motorized unit to where the mast section must be installed.
- 3- Using any appropriate lifting device such as a crane or a rough terrain forklift, lift and carry the next mast section.
- 4- Align the mast section to be installed on the bottom mast section. Insert the alignment tabs on top of the bottom section into the bottom tubes of the section to be installed, making sure the mast sections line up square and that rungs for the hooks are on the same side. Anti error stubs will prevent the joining of the two mast sections if the top mast section is not oriented properly.
- 5- Flip the 5/8" x 6 1/2" toggle bolt, mast clamp and flange nut onto the connecting lug (fig. 5.1) and tighten by hand. Perform this operation for all four (4) corners.
- 6- Tighten all toggle bolts with a torque of 120 lb-ft (163 N-m). Use a cross-pattern sequence when tightening (fig. 5.4).
- 7- Repeat steps 2 through 6 for each mast section to be installed at every 5' (1,5 m) of rise.
- 8- Always make sure that the mast assembly is plumb on both the front and side axis.
- 9- It is important to verify the mast bolts when lowering the platform to make sure they are in good condition and are tightened properly, especially on **brand-new mast sections**, as the galvanized coating may have compressed. In all cases, mast bolts must be tightened with a torque of 120 lb-ft (163 N-m). Overtightening or undertightening mast bolts may lead to equipment damage.

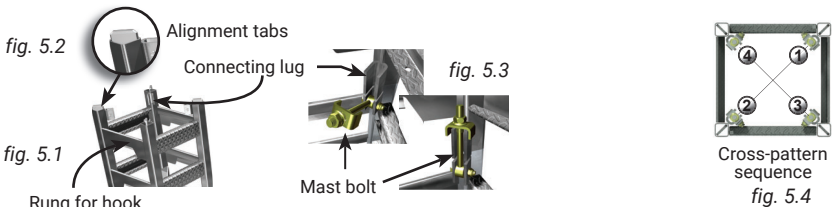

- 10- For instructions on the installation of assembled lengths of mast sections, refer to the installation instructions starting on p. 16 of the *Motorized Unit* section, and to the instructions on the use of the multiple mast handler on p. 54 of the *Accessories* section. It is important to verify the mast bolts of assembled lengths of mast to make sure they are tightened properly.



NOTICE

It is important to inspect mast sections and mast bolts following the recommended inspection schedules. Failure to inspect mast sections and mast bolts in a timely fashion can lead to equipment damage and premature wear.

Removal of a single mast section

- 1- Loosen each toggle bolt assembly and disengage from the connecting lug (fig. 5.1).
- 2- Using any appropriate lifting device such as a crane or a rough terrain forklift, lift the top mast section off the bottom mast section.

If mast sections are to be stored on the platform during dismantling, make sure they are **set down horizontally and distributed equally on either side of the mast to ensure good balance**. Refer to the *Load Capacities* section on p. 47 for more information about loading the platform.

Mast and Mast Ties

Mast Sections

Transport and storage of mast sections

- 1- Mast sections can be carried in 20' (6,1 m) segments provided they are set down horizontally on a flat surface. Make sure that mast sections bolted together in 20' (6,1 m) segments are stored and secured so as to remain straight during road transport.
- 2- Mast sections can also be transported in bundles. For best results when carrying mast sections in bundles, it is recommended to strap them in groups of nine (9). Make sure that mast sections positioned in the middle are securely strapped to the other sections to prevent them from slipping out during transport.
- 3- Store mast sections on a flat surface away from work areas and construction traffic. For instructions on the storage of mast sections, refer to p. 58 of the *Transport, Storage and Maintenance* section.



WARNING

It is important to make sure to verify the mast bolts when lowering the platform to make sure they are tightened properly and are in good condition, especially on **brand-new mast sections**, as the galvanized coating may have compressed. Make sure to also verify mast bolts of assembled lengths of mast. In all cases, mast bolts must be tightened with a torque of 120 lb-ft (163 N-m). Overtightening or undertightening mast bolts may lead to equipment damage.

Installation of Tie Levels

fig. 5.7

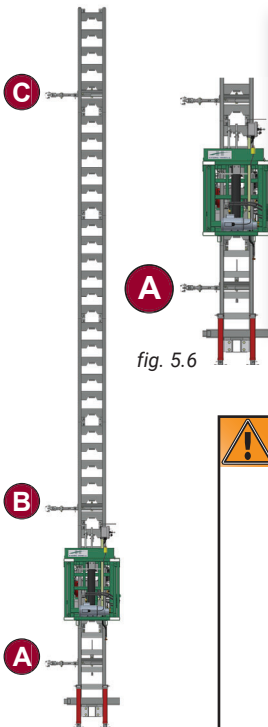

fig. 5.6

fig. 5.5

Tie Level Installation Schedule		
NO FREESTANDING ALLOWED		
A	A	Between 2' and 4' (0,6 m and 1,2 m) from base level
B	B (from A)	Between 5' (15 m) and 10' (3 m)
C	C (from B) and subsequent	Up to 20' (6,1 m)
Height of mast above last tie level with two tie levels in place		20' (3 m)
Height of mast above last tie level with one tie level in place		NOT ALLOWED



WARNING

The **erection** and **dismantling** of a motorized unit setup (including the base, the bridges, the masts, the mast ties and all the other components) must not be conducted when wind speeds exceed **28 mph (45 km/h)**. Freestanding installation and setups equipped with weather protection, when allowed, must not be used with wind speeds exceeding **28 mph (45 km/h)**. Weather protection, when allowed, must not be used when work is performed on an open air structure. A motorized unit with mast ties must not be used when wind speeds exceed **35 mph (56 km/h)**. It is important to inspect every component of a motorized unit installation that has been exposed to conditions that could have compromised or altered the structural integrity and stability of the installation.

When the motorized unit is not in use:

- It is mandatory to bring the platform down to base level or to leave the platform between two tie levels.
- All loads must be removed from the platform.
- It is mandatory to leave all the counterweights applied on the setup in place.
- In a freestanding installation, when allowed, the motorized unit must be brought down to base level.
- If wind speeds are expected to exceed **94 mph (150 km/h)**, the motorized unit must be brought down to base level.

Mast and Mast Ties Installation of Tie Levels

The **standard width of planking** for a P Series narrow motorized unit installation is **two planks**. The **maximum width of planking allowed** for a P Series narrow motorized unit installation is **three planks**. The width of planking required for the P Series narrow motorized unit installation will determine which type of mast tie attachment and mast ties must be used.

Mast Tie Requirements for Planking Configurations

Mast tie requirements for 0 to 1-plank configurations

A P Series narrow motorized unit installation with a 0 to 1-plank configuration requires the use of a narrow mast tie attachment / mast tie combination assembly (fig. 5.8).

Mast tie requirements for 2 to 3-plank configurations

A P Series narrow motorized unit installation with a 2 to 3-plank configuration requires the use of a type 2 mast tie attachment assembly (fig. 5.10) and standard mast ties.

Mast tie attachment/mast tie combination assembly for 0-1 plank configuration (narrow installation)

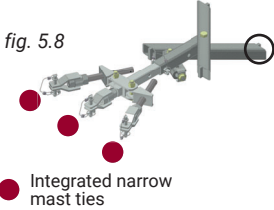

Mast tie attachment assembly and mast ties for 2-3 plank configuration

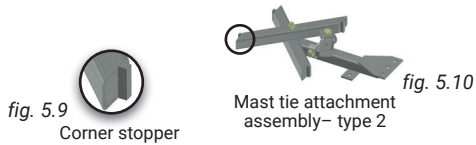
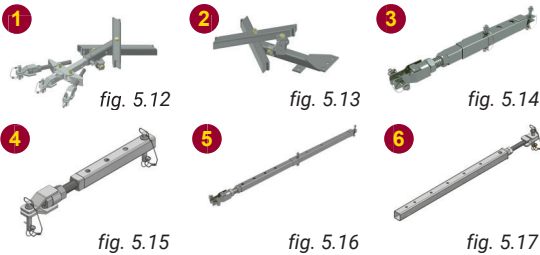

fig. 5.11

Mast Tie Components Requirements						
Number of planks	COMPONENTS					
	1 Mast tie attachment (narrow)	2 Mast tie attachment - type 2	3 Mast tie short assembly	4 Mast tie short male assembly	5 Mast tie assembly	6 Mast tie male assembly
0	1	0	0	0	0	0
1	1	0	0	0	0	0
2	0	1	3	0	0	0
3	0	1	0	0	2	1



1	Mast tie attachment/mast tie combination assembly (narrow installation)
2	Mast tie attachment - type 2
3	Mast tie short assembly
4	Mast tie short male assembly
5	Mast tie assembly
6	Mast tie male assembly



NOTICE

It is important to make sure that the distance between the front edge of the motorized unit and the face of the work includes 6" (15,5 cm) of play. In one-plank configurations, it **may be required** to use **custom-sized planking** to allow for that play.

Mast and Mast Ties

Installation of Tie Levels

Installation of mast ties

- 1- Make sure that all the components appropriate for the planking configuration are available. Refer to the instructions on the previous page for more information.
- 2- When choosing a planking configuration, make sure that the distance between the front edge of the motorized unit and the face of the work includes 6" (15,5 cm) of play. In one-plank configurations (fig. 5.20), it may be **required** to use **custom-sized** planking to allow for that play.
Refer to the diagrams below and to the *Mast Tie Components Requirements* table on p. 40 of this section to choose the mast tie components appropriate for the planking configuration required by the setup.
- 3- Slide the mast tie attachment assembly into the mast section.
- 4- Spread open the mast tie attachment assembly until the four corner stoppers (fig. 5.9, p. 40) are positioned properly and snug against the mast structure.
- 5- Push the 5/8" x 6 1/2" toggle bolt assembly inside the connecting lug to secure the mast tie attachment. Tighten the bolt with a torque of 60 lb-ft (80 N-m).
- 6- Pin the center mast tie to the wall tie and adjust its length until the mast is perfectly plumb on the front axis. Use the threaded rod for adjustment, leaving a maximum length of threaded rod inside the tube for added strength.
- 7- Pin the other two mast ties to the wall ties and use the threaded rods to adjust their length until the mast is perfectly plumb on the side axis.

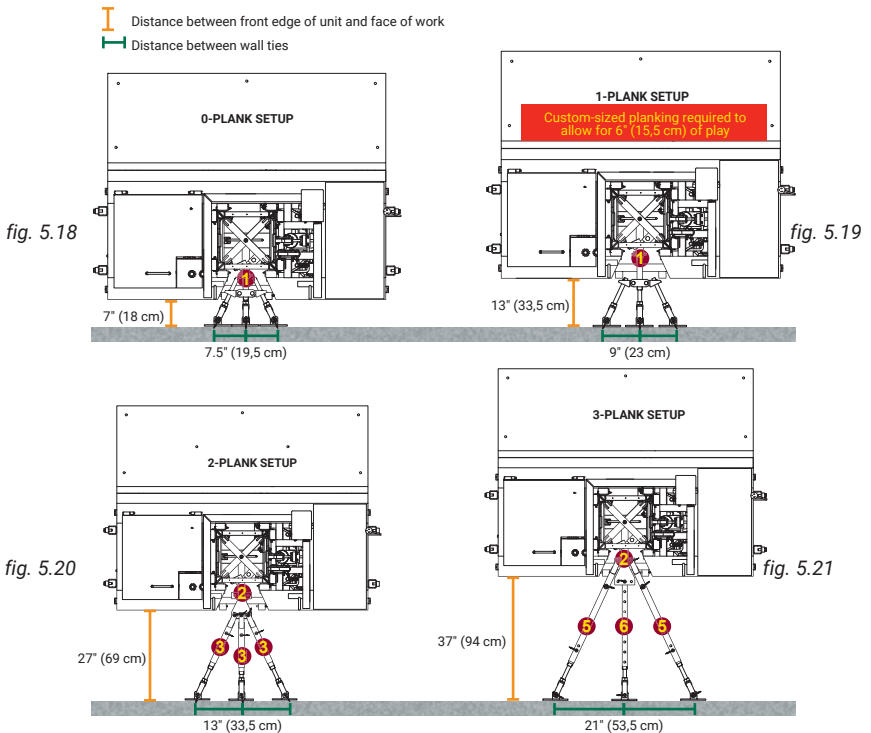

Passing tie levels

The use of fall protection equipment is **mandatory** to handle operations when passing tie levels. To safely pass tie levels, slide planks away from the front area of the mast. The use of shorter planks will facilitate this task. It is recommended to use the designated tie points located on the motorized unit to anchor the fall protection equipment.

Mast and Mast Ties

Installation of Tie Levels

Removal of mast ties

- 1- Loosen the adjustment rod on one of the outer mast ties (fig. 5.22) until the mast tie is loose enough to be easily unfastened from the wall tie installed on the face of the work. **It is mandatory to make sure that all tension (or compression) is released from the mast tie before attempting to unpin it from the wall tie.**
- 2- Repeat step 1 for the outer angle mast tie, then for the center mast tie. The center mast tie must be the last mast tie removed.
- 3- Before removing the last tie level close to the base, make sure that **the motorized unit is stable.**

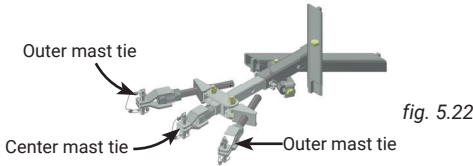

CAUTION

It is mandatory to make sure that all tension (or compression) is released from the mast tie before attempting to loosen the clamp and unpin the mast tie from the wall tie.

Angled Mast Ties

Some mast tie configurations require that the mast ties be installed at an angle (between 5 and 30 degrees from horizontal) through windows or other building openings (fig. 5.27). An angled mast tie configuration can only be achieved with a **type 2 mast tie attachment assembly** (fig. 5.23). Angled mast tie configurations require the use of the optional 30-degree mast tie kit (fig. 5.28, p. 43) and wall ties for horizontal anchoring installations (fig. 5.26). An angled mast tie installation **must not exceed** a 30-degree angle from horizontal (fig. 5.34, p. 44).

Each mast tie in an angled mast tie configuration must only be a combination of one standard mast tie assembly and only one optional mast tie extension.

Installation of the mast tie attachment assembly

- 1- Slide the mast tie attachment assembly into the mast section. Make sure the mast tie attachment assembly is installed directly below or above a mast rung.
- 2- Spread open the mast tie attachment assembly until the four corner stoppers (fig. 5.24) are positioned properly and snug against the mast structure.
- 3- Push the 5/8" x 6 1/2" toggle bolt assembly inside the connecting lug to secure the mast tie attachment assembly. Tighten the bolt with a torque of 60 lb-ft (80 N-m).

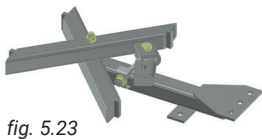

Mast tie attachment assembly—
type 2



Corner stopper

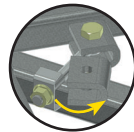
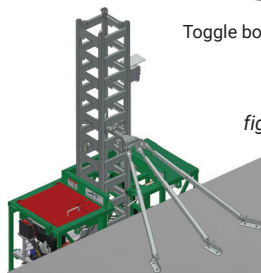

fig. 5.25

Toggle bolt assembly



Wall tie for horizontal
anchoring installation



Mast and Mast Ties

Angled Mast Ties

Installation of the angle bracket

- 1- Insert the top part ("A" in fig. 5.28) of the 30-degree mast tie bracket assembly in the mast, over the mast tie attachment assembly. Make sure both bars are properly inserted in the front and back mast rungs and that the fillers (welded tubes) are positioned on top of the lower tube of the mast tie attachment assembly (fig. 5.29).
- 2- Insert the bottom part of the 30-degree mast tie bracket assembly ("B" in fig. 5.28) under the mast tie attachment assembly.
- 3- Align the top and bottom parts of the 30-degree mast tie bracket assembly. Assemble both parts with four 5/8" bolt and nut assemblies. **Do not tighten bolt assemblies yet.**
- 4- Slide the tube of the angle bracket ("C" in fig. 5.28) into the tube of the mast tie attachment assembly. Secure the angle bracket to the mast tie attachment assembly with three 9/16" bolt assemblies.
- 5- Tighten all bolt assemblies with a torque of 60 lb-ft (81 N-m).

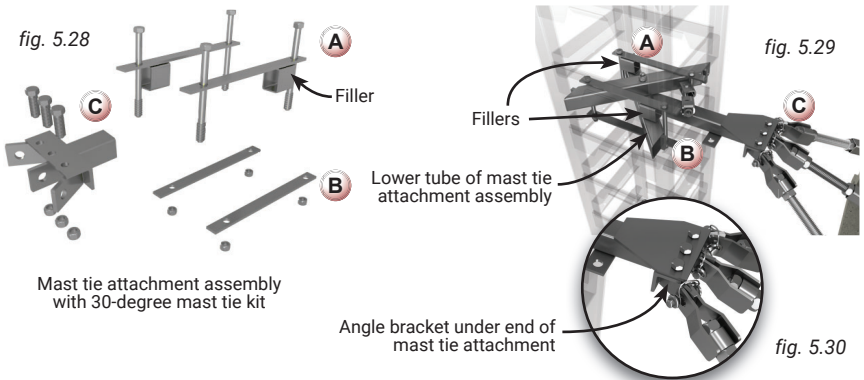

Assembly of an extended mast tie

- 1- Remove the mast tie pin holding both ends of the mast tie assembly together.
- 2- Insert the male end of the mast tie assembly ("D" in fig. 5.31) into the female end of the mast tie extension ("E" in fig. 5.32) and secure with a mast tie pin.
- 3- Insert the male end of the mast tie extension ("F" in fig. 5.32) into the female end ("G" in fig. 5.31) of the mast tie assembly and secure with a mast tie pin.
- 4- Repeat steps 1 through 3 for each required extended mast tie.

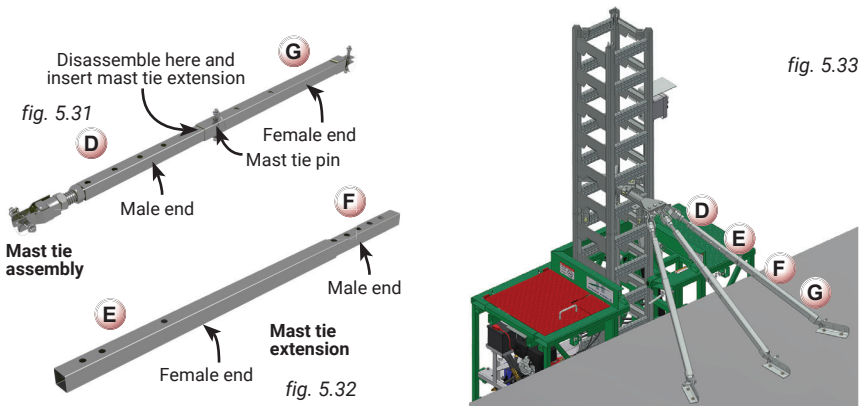

Mast and Mast Ties Angled Mast Ties

Installation of extended mast ties

- 1- Pin an extended mast tie to the center of the mast tie attachment assembly using a clevis pin and a linch pin.
- 2- Pin the center mast tie to the floor tie and adjust its length until the mast is perfectly plumb on the front axis. Use the threaded rod and the pin for adjustment, leaving a maximum length of threaded rod inside the mast tie tube for added strength. The tie adjustment rod has a maximum extension of 6" (15,5 cm). Wall ties used for horizontal anchoring must be able to sustain 1500 lb (680 kg) of tension/compression and 3000 lb (1361 kg) of shear force.
- 3- Repeat steps 1 and 2 to install the other required extended mast ties at a 25° angle (fig. 5.34) and use the threaded rods to adjust their length until the mast is perfectly plumb on the side axis.

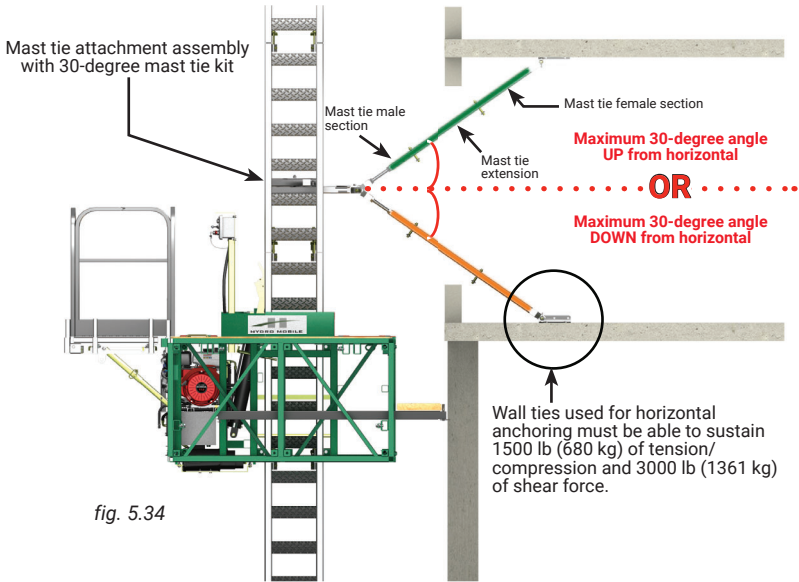

fig. 5.34

P Series standard motorized unit shown for illustration purposes; all information also applies to the P Narrow motorized unit

- 0 to 30-degree **UPPER** angle
- OR
- 0 to 30-degree **LOWER** angle

Calculation of a mast tie angle

A 5-degree slope represents a 12" to 1" (30 cm to 2,5 cm) ratio

12" (30 cm)

1" (2,5 cm)

A 30-degree slope represents a 12" to 7" (30 cm to 18 cm) ratio

12" (30 cm)

7" (18 cm)

N

NOTICE

An angled mast tie installation **must not exceed** a 30-degree angle from horizontal. Only **one** optional mast tie extension is allowed for **each** mast tie in an angled mast tie configuration.

Mast and Mast Ties Anchoring System

Wall tie reactions

Before attaching masts to the building using the mast tie system, wall ties must be installed on a solid component of the building structure. It is important to understand that whether the anchoring installation is a horizontal or vertical type (fig. 5.37 and fig. 5.38), values for tension / compression and shear forces will be **inverted**.

Concrete slabs, columns, steel beams, relief angles and other structural elements can be used provided they and the selected anchoring system can sustain 3000 lb (1361 kg) of tension / compression and 1500 lb (680 kg) of shear force for a **vertical anchoring installation** and 1500 lb (680 kg) of tension / compression and 3000 lb (1361 kg) of shear force for a **horizontal anchoring installation**.

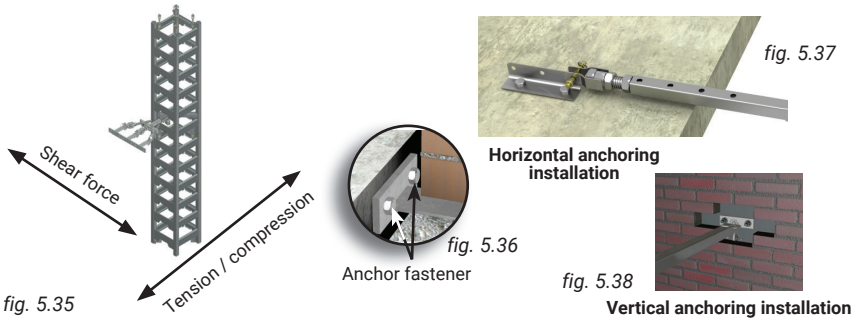

Each anchor fastener shown in fig. 5.36 must be able to sustain appropriate tension / compression and shear force for the application. Refer to p. 45 of this section for more information. A total of six anchor fasteners (minimum two per wall tie bracket) is required for each tie level.

Installation of wall ties

Most anchor fastener manufacturers specify a maximum distance from the edge of a slab at which an anchor fastener must be installed to obtain its maximum working load. The thinner the slab, the less available area there is to obtain that working load.

WARNING

It is mandatory to refer and conform to the anchor fastener manufacturer's specifications for the capacity, embedment, required distance from edge and application reduction factors of the fastener, manufacturer's recommended installation method, etc.

Wall tie types

There are 4 types of wall ties that can be used – welded, re-usable (centered or offset) and for horizontal/vertical installation. As the installation is rising, install the wall ties as per the appropriate tie level installation schedule (see p. 39).

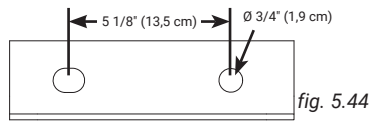
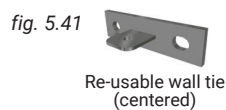

Drill-hole template for all wall ties

Mast and Mast Ties

Anchoring System

Installation guidelines for horizontal anchoring

Horizontal anchoring can be installed at angles ranging from 0° up to 30° from horizontal. Wall ties used for horizontal anchoring installations must be able to sustain 1500 lb (680 kg) of tension/compression and 3000 lb (1361 kg) of shear force.

Installation guidelines for a re-usable wall tie

Used mainly for masonry work projects, the re-usable wall tie is installed in a cavity left unfilled in a brick wall under construction.

When dismantling the setup and removing mast ties, the re-usable wall tie is removed and the brickwork is completed.

Installation guidelines for a fixed wall tie

Fixed wall ties can be installed on a wall between two layers of brick (fig. 5.45). It is important to make sure that several layers of brick have been laid on top of the fixed wall ties and that the mortar has cured properly **before attaching mast ties to the wall ties**.

Distance between the anchoring structure and the back of the brick wall must not be greater than 1 1/2" (3,8 cm), as shown in fig. 5.46.

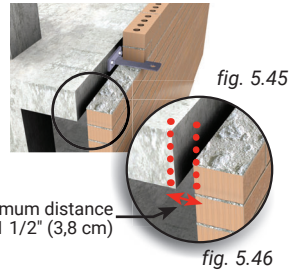

Installation guidelines for a welded wall tie on a beam

The welded wall tie is 6 7/8" (17,5 cm) long and must protrude from the beam by a maximum of 3 7/8" (10 cm) as shown in fig. 5.48. If an angled mast tie will be attached to the welded wall tie, the wall tie must be installed at the same angle as the mast tie.

When a welded wall tie is installed at an angle, as shown in fig. 5.49, the maximum length of 3 7/8" (10 cm) must be calculated on the longest side of the angled wall tie.

The welding electrode used must be E70-XX series.

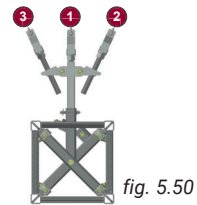
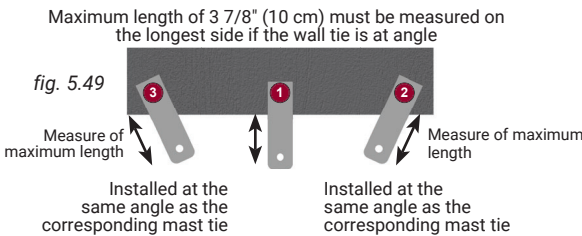
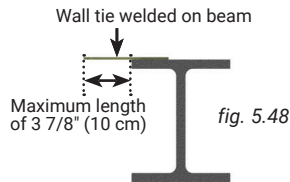
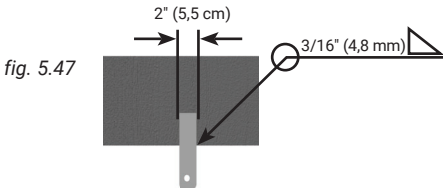

N	NOTICE
It is important to note that M1 Series wall ties do not meet minimum strength requirements for current Hydro Mobile equipment setups.	

Load Capacities

General guidelines

- 1- **The weight of planks and any additional accessory being used must be deducted from the load capacities.**
- 2- **Each worker's weight (personal tools and equipment included) must be deducted from load capacities.**
- 3- To ensure stability it is recommended that the loads applied on the platform be as evenly distributed as possible.
- 4- To ensure stability in a single unit setup, the length of cantilever bridges on either side of the unit must be equal at all times.
- 5- To ensure stability in a twin units setup, the minimum load applied on the bearing bridge must be similar to the total load applied on the cantilever bridges.
- 6- It is recommended that there be a **maximum** number of workers for each installation, calculated as follows: overall length of installation divided by 15' (4,6 m) and rounded **up**, PLUS two workers for each motorized unit in the installation, with at least one of those two workers being a qualified operator of a P Series motorized unit and its accessories. For example, on a setup with an overall length of 95' 5" (29,1 m), the calculation would be: 95' 5" / 15 (or 29,1 m / 4,6 m) rounded up to **7**, PLUS **two workers for each** motorized unit (in this case, two units) = **4**, resulting in a **maximum of 11 workers** for the installation, including **two qualified operators**. Refer to p. 7 of the *Performance and Safety Rules* section for the definition of a qualified operator.

Calculating the maximum number of workers allowed on a given installation	
Formula	Calculation example for a 95' 5" (29,1 m) installation
Overall length of installation / 15' (4,6 m), rounded up	95' 5" (29,1 m) / 15' (4,6 m), rounded up → 7
+	+
Two (2) workers per motorized unit in the installation	Two (2) workers for each motorized unit in the installation → 4
	Total of workers allowed on installation → 11

fig. 6.1

- 7- The weight of each person working in a given area reduces the load capacity of that area.
- 8- **The load capacity charts stickers displayed on the motorized unit used in the setup will take precedence over the information included in this owner's manual.**
- 9- Twin mast setups can be a combination of any cantilever bridge configuration with any bearing bridge shown on the charts. The maximum length of cantilever bridge allowed for a P Series narrow installation is 15' 7" (4,7 m). The maximum length of bearing bridge allowed for a P Series narrow installation is 46' 8" (14,2 m).
- 10- To calculate the load capacity of a standard, authorized single or multiple unit configuration that is not shown in the charts included in this manual, take the length of the bridge to be installed and refer to the capacities of the bridge in the chart that is longer and closest to it. For example, for a 41' 6" (12,6 m) bearing bridge, the load capacities of a 46' 8" (14,2 m) bearing bridge would be used.



NOTICE

The load capacities charts stickers displayed on the motorized unit used in the setup will take precedence over the information included in this owner's manual.

Load Capacities

Evenly distributed – Single unit setup

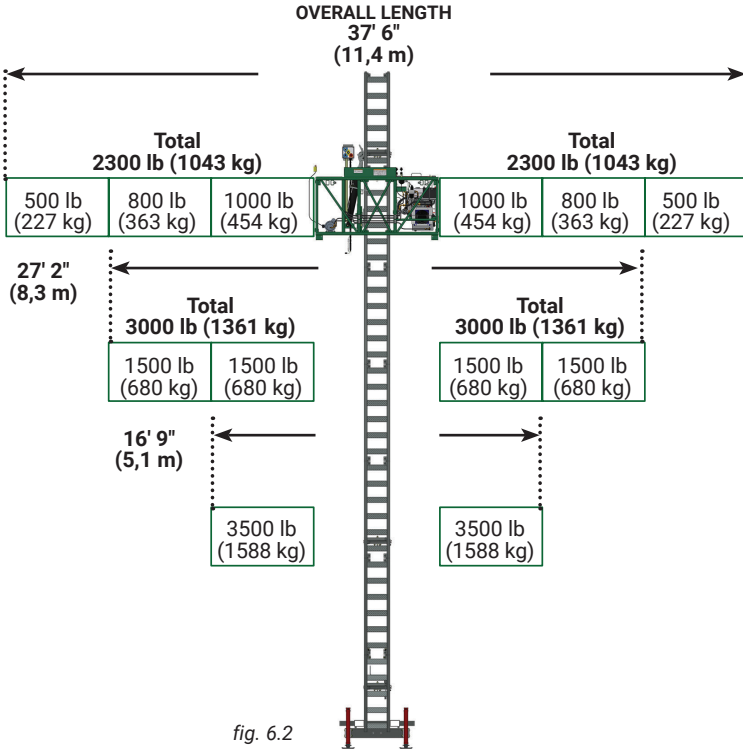

WARNING

To ensure safety at all times on a mast climbing work platform system, bridges must not be loaded beyond their maximum rated weight capacities. In addition, to prevent a mast climbing work platform system from stalling because of an overload, maximum rated load capacities of the motorized unit(s) should be observed. Overloading a mast climbing work platform system could result in serious injury or death.

Make sure that there are never two workers standing on the same plank outrigger at the same time.

To calculate the load capacity of a standard, authorized configuration not shown in the chart above, refer to step 10 of the *General Guidelines* on p. 47 of this section.

LEGEND

	Multi-purpose bridge		Twin mast adapter - type NW
--	----------------------	--	-----------------------------

Safety Accessories

SAFETY comes first. While most hazards that may occur when operating a P Series motorized unit (standard or NW) setup can be avoided by using extreme care and common sense, the use of safety accessories, such as appropriate guardrails and supports, is recommended when areas and activities involve heights or positioning of the setup that put workers at risk.

Guardrails

In all cases where workers are exposed to fall hazards greater than specified by local regulations, the installation of appropriate guardrails is **mandatory** to ensure safety. It is important to make sure that **all guardrails required for the configuration are available** as some may not be included with bridges and may have to be purchased separately.

Guardrails included with the P Series narrow motorized unit

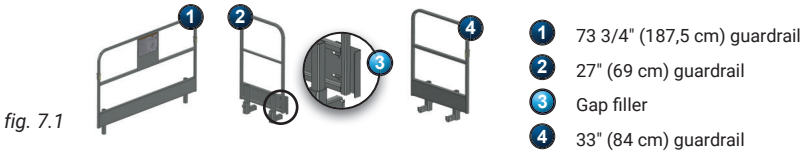

Required optional guardrails



Guardrails required for typical single unit configurations

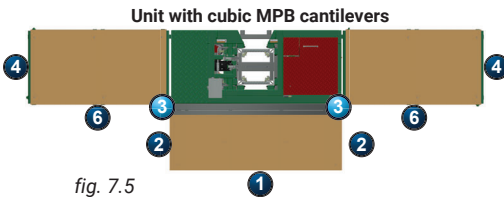
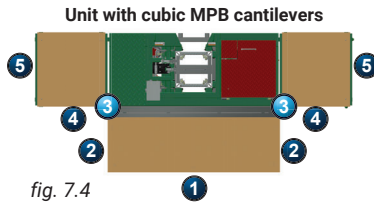
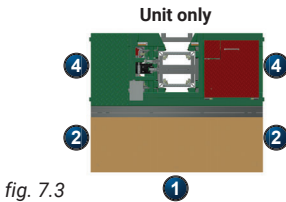

Guardrails required for a typical twin units configuration

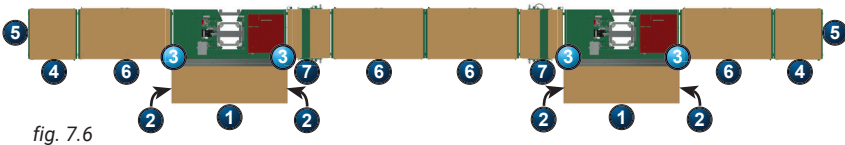

Safety Accessories

Guardrails

Installation of a guardrail adapter bracket

- 1- Slide a guardrail adapter L bracket (fig. 7.7) in each of the two guardrail pockets and secure them with toggle pins.
- 2- Insert the guardrail legs in the vertical part of the adapter brackets and tighten the bolts on the adapter brackets to secure the guardrail.

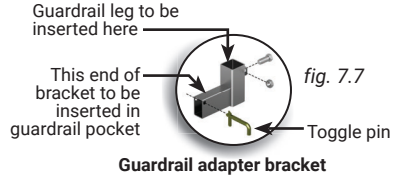

Installation of the 73 3/4" (187,5 cm) guardrail on the rear platform extension

- 1- Make sure that the rear platform extension is lifted and secure. Retrieve the guardrail adapter brackets stored at one end of the motorized unit (fig. 7.8).
- 2- Install the two guardrail adapter brackets in the guardrail pockets on the rear platform extension (see "1" in fig. 7.13 for location of pockets).
- 3- Insert the guardrail legs in the vertical part of the adapter brackets. Tighten the bolts on the adapter brackets with a torque of 30 lb-ft (41 N-m) to secure the guardrail.

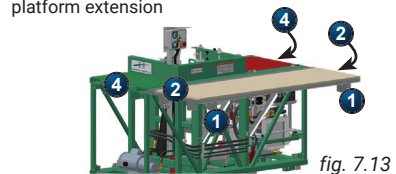
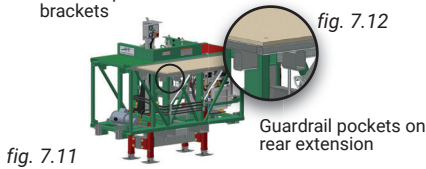
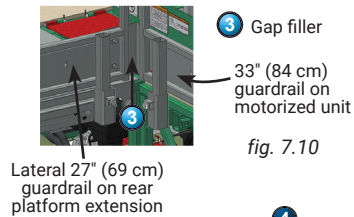
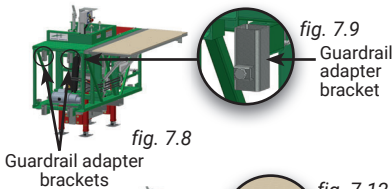

Installation of the 27" (69 cm) guardrails on the rear platform extension

- 1- Make sure that the rear platform extension is lifted and secure.
- 2- Make sure the two guardrail adapter brackets are installed in the guardrail pockets on the rear platform extension (see "2" in fig. 7.13 for location of pockets).
- 3- Insert the guardrail legs in the vertical part of the adapter brackets. Tighten the bolts on the adapter brackets with a torque of 30 lb-ft (41 N-m) to secure the guardrail.
- 4- Repeat to install the guardrail at the other end of the rear platform extension.

Adjustment of gap fillers on 27" (69 cm) guardrails

The lateral 27" (69 cm) guardrails are equipped with adjustable gap fillers to fill the gaps between the rear extension guardrails and guardrails installed on bridges adjacent to the motorized unit. The adjustment of the gap fillers is required.

- 1- Make sure that the gap filler on each of the lateral 27" (69 cm) guardrails is positioned at the end that is close to the adjacent guardrail (fig. 7.10).
- 2- Pull out each gap filler until it reaches the adjacent guardrail and tighten the bolts to secure in place.

Installation of the 33" (84 cm) guardrails on the motorized unit

- 1- Make sure the two guardrail adapter brackets are installed in the guardrail pockets on the motorized unit (see "4" in fig. 7.13 for location of pockets).
- 2- Insert the guardrail legs in the vertical part of the adapter brackets. Tighten the bolts on the adapter brackets with a torque of 30 lb-ft (41 N-m) to secure the guardrail.
- 3- Repeat to install the guardrail at the other end of the motorized unit.

Safety Accessories

Guardrails

Installation of a guardrail on a multi-purpose bridge (standard or cubic)

- 1- Make sure the two guardrail adapter brackets are installed in the guardrail pockets on the multi-purpose bridge (see fig. 7.14 and fig. 7.15 for location of pockets).
- 2- Insert the guardrail legs in the vertical part of the adapter brackets. Tighten the bolts on the adapter brackets with a torque of 30 lb-ft (41 N-m) to secure the guardrail.

Installation of a universal twin mast adapter guardrail on a twin mast adapter

- 1- Insert the guardrail legs in the vertical guardrail pockets on the twin mast adapter (fig. 7.16).
- 2- Tighten the bolts on the guardrail pockets with a torque of 30 lb-ft (41 N-m) to secure the guardrail.

Multi-purpose cubic bridge

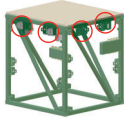

fig. 7.14

Guardrail pockets

Multi-purpose bridge

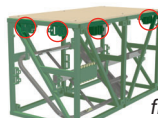

fig. 7.15

Guardrail pockets

Twin mast adapter



fig. 7.16

Guardrail pockets

Plank-End Guardrail

Plank-end guardrails must be installed at the ends of planking as fall protection. In a three-plank configuration, the opening must be closed by placing two plank-end guardrails **face to face**.

Overlapping plank-end guardrails



fig. 7.17

Installation

- 1- Slide the bottom end of the plank-end guardrail over the end of two planks.
- 2- Drive one or two nails or screws into the planks through the top plate to secure the guardrail in place.
- 3- A three-plank configuration will require the installation of two plank-end guardrails. Follow steps 1 and 2 to install the first plank-end guardrail.
- 4- Slide a second plank-end guardrail backwards over the end of two planks, overlapping the first one installed. Secure the second guardrail in place as described in step 2.

fig. 7.18



Plank-end guardrail

Face Guardrail Supports

(optional)

Face guardrail supports must be installed when the distance between the end of planking (or deck, if not using planks) and the structure is greater than what local regulations allow (ex. recess in a wall, end of a building, etc.).

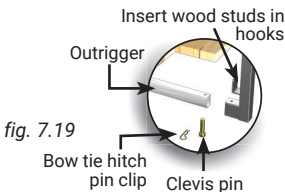
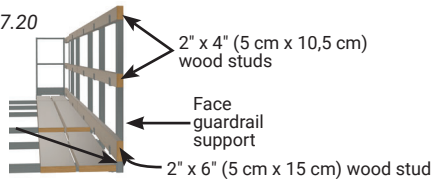

fig. 7.19

fig. 7.20



Installation

- 1- Remove the plank stop pin from the outrigger and slide the face guardrail support over the outrigger tube.
- 2- Slide a clevis pin through the face guardrail support and the outrigger. Secure the support in place with a bow tie hitch pin clip.



NOTICE

Face guardrail supports must be installed every 5' (1,5 m).

Safety Accessories

Face Guardrail Supports (optional)

Installation (cont'd)

- Repeat steps 1 and 2 for each guardrail face support required to secure the hazardous opening.
- Insert wood studs in the hooks of each face guardrail support to cover the hazardous opening. It is important to make sure to use 2" x 6" (5 cm x 15 cm) wood studs at the bottom position. Secure the studs in place with nails or screws.
- Tighten all outrigger pocket bolts with a torque of 30 lb-ft (41 N-m).

Movable Guardrail (optional)

To ensure the safety of workers in a more flexible way, movable guardrails may be installed on bridges. Follow the installation steps of a standard guardrail and secure the movable guardrail to the standard guardrail with toggle pins.

Universal Plank Safety Support (optional)

The universal plank safety support is installed at the extremities of planking to prevent planks from lifting, tipping and slipping.

Installation

- Lift and hold the stop pin (fig. 7.21) and slide the plank safety support between two planks.
- Secure the C-shaped bracket around the outrigger and release the stop pin.
- Using screws or nails, secure the top plate of the plank safety support to the planks (fig. 7.22).

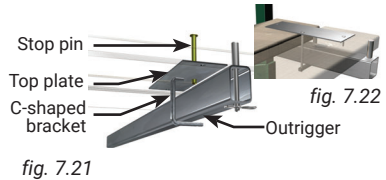

Access Stairs (optional)

When the motorized unit is at base level, workers may use the optional access stairs to reach the platform. The access stairs can be installed **on a bridge** in the setup but **not on the motorized unit**. The installation of the access stairs assembly reduces the load capacity of the area where it is put in place.

Installation

- Install the door guardrail ("4" in fig. 7.23) by sliding the guardrail legs in the guardrail pockets on the bridge. Secure the door guardrail with two toggle pins.
- Slide the top part of the stairs into the top outrigger pockets (fig. 7.24).
- Unfold the stair brace.
- Secure the stair brace to the bottom chord of the bridge ("6" in fig. 7.23) with two toggle pins.
- Secure the top part in place by sliding in two toggle pins and tightening each outrigger pocket bolt.
- Install the two handrails ("1" in fig. 7.23) and secure in place and tighten the bolts.
- If the height between the bearing surface and the first step is greater than what is allowed by local regulations, it is mandatory to install one or more optional extension stairs ("3" in fig. 7.23). A **maximum of three** extension stairs is allowed per access stairs installation.

- Handrail
- Stairs
- Extension
- Door guardrail
- Top outrigger pockets
- Bridge bottom chord

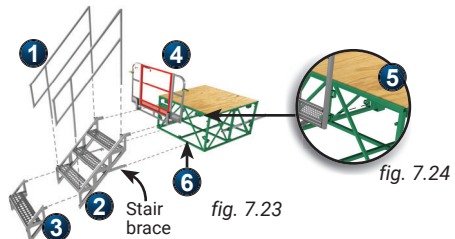

Accessories

Outriggers

Outriggers can be installed on both top and bottom levels on a P Series narrow motorized unit and on multi-purpose bridges. Plank support outriggers must be installed 5' (1,5 m) from one another and can be inserted from the **front** or the **back** of the bridge or motorized unit.

Plank support outriggers are not designed to support the weight of material and each outrigger has a maximum capacity of 265 lb (120 kg). Standard 63" (1,6 m) outriggers, used either at the top or bottom position, can be pulled out to a maximum of 30" (76 cm).

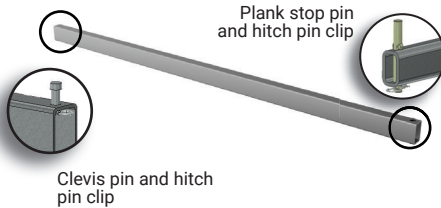

fig. 7.25

If space is restricted (see fig. 7.28), make sure all required outriggers are of the proper length for the configuration and space restrictions and that they are inserted into the bridge **before** it is installed.

Installation

- 1- Remove the clevis pin and the plank stop pin (fig. 7.25) and slide the outrigger in the top outrigger pockets on the motorized unit or the bridge, leaving no more than 20" (50,8 cm) protruding from the structure if bottom outriggers are installed, or no more than 31" (78,7 cm) if there are no bottom outriggers installed. Replace the clevis pin and the plank stop pin.
- 2- Once the planks are in place, push in each outrigger until the plank stop pin rests snugly against the planks. Repeat for each outrigger to be installed.
- 3- Secure the outriggers in place by tightening the outrigger pocket bolts with a torque of 30 lb-ft (41 N-m).

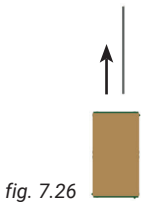

fig. 7.26

The outrigger must be removed from the multi-purpose bridge before it is installed

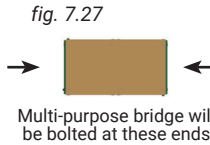

fig. 7.27

Multi-purpose bridge will be bolted at these ends



fig. 7.28

Outriggers must be of the proper length and inserted in bridges before installation when space is restricted



CAUTION

Outriggers may stick out from the rear of the platform. The maximum planking configuration allowed on the front of P Series narrow installations is three planks.

Multiple Mast Handler (optional)

The use of the multiple mast handler will allow the qualified erector/dismantler to install or remove assembled lengths of mast (also referred to as "sticks") and reduce the time required to achieve the installation or the dismantling of the setup.

General guidelines

- 1- The length of assembled mast allowed must be equal to the authorized length of mast in feet (meters) to reach the level at which to install the next tie level, according to the tie level installation schedule specific to the installation, or remove the next tie level.
- 2- For more information about distances between tie levels, refer to the *Tie Level Installation Schedule* table on p. 39 of the *Mast and Mast Ties* section.

Accessories

Multiple Mast Handler
(optional)

Installation of assembled lengths of mast sections

- 1- Assemble a length of mast sections on the ground. Mast sections must be laid down horizontally on the ground. For instructions on the assembly of mast sections, refer to p. 38 of the *Mast and Mast Ties* section. Tighten all bolts with a torque of 120 lb-ft (163 N-m), using a cross-pattern sequence.
- 2- Install the mast handler on the highest rung of the lowest mast section of the assembled length of mast (fig. 7.31).
- 3- It is important to consider the weight of the assembled length of mast that must be lifted and to make sure to select a sling, chain or cable that can lift that weight. For example, a 20' (6,1 m) length of assembled mast sections will weigh 940 lb (426 kg).
- 4- Insert the sling (or chain or cable) through the assembled length of mast and attach the hook to the shackle on the mast handler.
- 5- Using a crane (or a forklift), carefully lift and lower the assembled length of mast on top of the last mast section installed.
- 6- Still holding the length of mast, attach the bottom mast section to the top of the mast section already installed. Tighten all bolts with a torque of 120 lb-ft (163 N-m), using a cross-pattern sequence.
- 7- Remove the shackle from the mast handler to release the hook and sling. Monitor the release of the sling to avoid potential interferences.
- 8- Remove the multiple mast handler from the mast section.
- 9- Raise the motorized unit on the newly added length of mast, making sure while rising that mast bolts are tightened with a torque of 120 lb-ft (163 N-m).
- 10- Install the next tie level. For instructions on the installation of a tie level, refer to p. 41 of the *Mast and Mast Ties* section.
- 11- Repeat steps 1 to 10 for each assembled length of mast to install, as required and allowed.

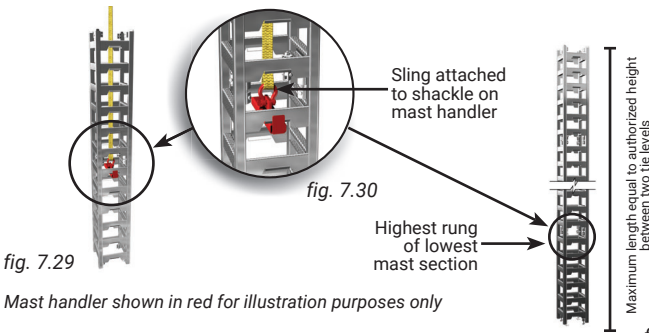

fig. 7.32

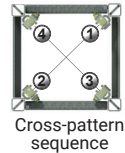

fig. 7.31

Removal of assembled lengths of mast sections

- 1- Bring the motorized unit to where a tie level must be removed. Remove the tie level. For instructions on how to remove a tie level, refer to p. 42 of the *Mast and Mast Ties* section.
- 2- Lower the platform to the next lower tie level.
- 3- Install the multiple mast handler on the highest rung of the bottom mast section of the assembled length of mast to remove (fig. 7.31).
- 4- It is important to consider the weight of the assembled length of mast that must be lifted and to make sure to select a sling, chain or cable that can lift that weight. For example, a 20' (6,1 m) length of assembled mast sections will weigh 940 lb (426 kg).
- 5- Insert the sling (or chain or cable) through the assembled length of mast and attach the hook to the shackle on the mast handler.
- 6- Remove all bolt assemblies joining the lowest mast section of the assembled length to the mast section below. For instructions on the removal of mast sections, refer to p. 38 of the *Mast and Mast Ties* section.
- 7- Using a crane (or a forklift), carefully lift the assembled length of mast and lower it down in a safe area, away from construction traffic.
- 8- Remove the multiple mast handler from the mast section.
- 9- Repeat steps 1 to 8 for each assembled length of mast to remove, as required and allowed.

Transport and Storage

Preparation of the motorized unit for transport and storage

- 1- Follow the dismantling guidelines appropriate to the installation. Refer to p. 21 of the *Motorized Unit* section for more information on dismantling an installation.
- 2- Make sure the motorized unit is at base level and turn off the engine.
- 3- Make sure that all workers have stepped down and that all tools, equipment and loads have been removed from the platform.
- 4- Open the engine access panel and move the engine gasoline valve lever to the OFF position (fig. 8.1 and fig. 8.2). Close the engine access panel.

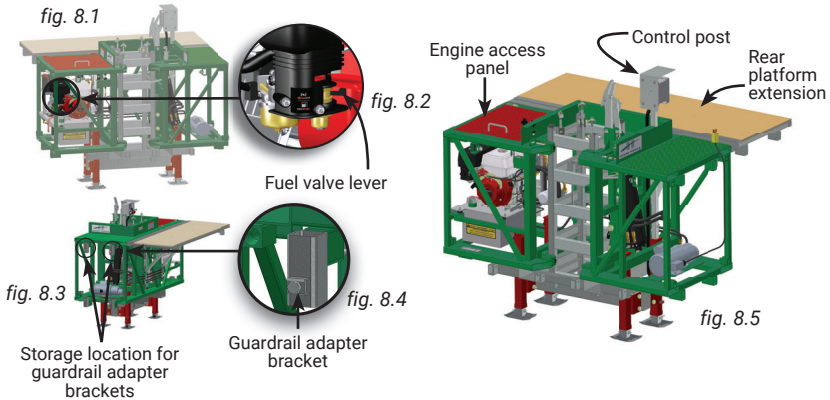

- 5- Store the control post. Refer to p. 59 of this section for instructions on how to store the control post.
- 6- Lower and secure the rear platform extension. For instructions on how to lower and secure the rear platform extension for transport and storage, refer to p. 13 of the *Motorized Unit* section.
- 7- Disconnect the battery.
- 8- Clean, store and secure all guardrails properly for transport. Refer to instructions on how to store the motorized unit guardrails further on in this section.
- 9- Clean and store each component properly.

Storage of the motorized unit guardrails

- 1- Inspect the structure of each motorized unit guardrail, including the inside of the open-end tubes, for any sign of damage or distortion. Clean each guardrail thoroughly to limit the effects of any corrosive agent.
- 2- Remove the guardrail adapters of the 73 3/4" (187,5 cm) guardrail and store them in the lateral guardrail pockets on the unit (fig. 8.9, p. 57). Secure the guardrail adapters with toggle pins.

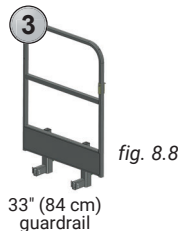
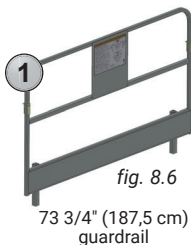

Transport and Storage

Storage of the motorized unit guardrails (cont'd)

- 3- Remove the guardrail adapters of both 27" (69 cm) guardrails. Insert the guardrail adapters of each 27" (69 cm) guardrail in the storage tubes located on the base of the motorized unit (fig. 8.12). Secure the guardrail adapters to the storage tubes with toggle pins.
- 4- Set the 73 3/4" (187,5 cm) guardrail on top of the tubes on the rear of the unit, as shown in fig. 8.13, behind the guardrail adapters.
- 5- Insert each 27" (69 cm) guardrail in the guardrail adapters installed on the base (fig. 8.14). Tighten the bolt on each guardrail adapter to secure the guardrails in place.

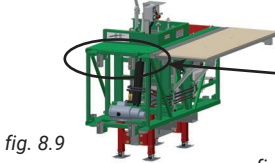

fig. 8.9



fig. 8.10

Guardrail adapters stored in lateral guardrail pockets on the unit

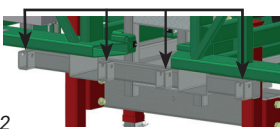

fig. 8.12

Guardrail adapters stored in tubes located on the base of the unit

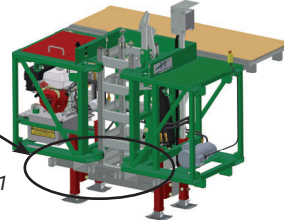

fig. 8.11

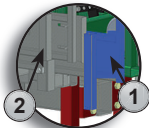

fig. 8.13

73 3/4" (187,5 cm) guardrail (in blue) behind 27" (69 cm) guardrails

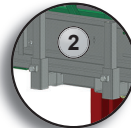

fig. 8.14

Guardrail adapters secured to storage tubes on the base

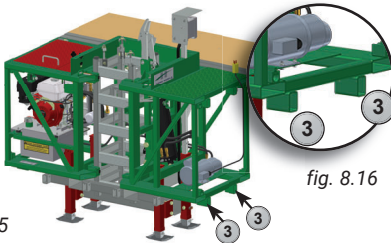

fig. 8.15

fig. 8.16

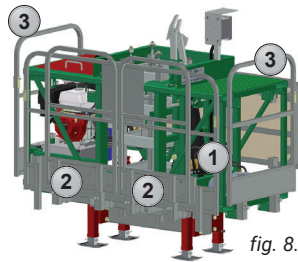

fig. 8.17

- 6- Insert the guardrail adapters of a 33" (84 cm) guardrail in the storage tubes located on the base of the motorized unit ("3" in fig. 8.15).
- 7- Secure the guardrail adapters to the storage tubes with toggle pins.
- 8- Repeat step 6 and 7 for the second 33" (84 cm) guardrail.

Transport and Storage

Storage of a bridge

- 1- Inspect the structure of the bridge, including the inside of the open-end tubes, for any sign of damage or distortion. Clean the bridge and its components thoroughly to limit the effects of any corrosive agent.
- 2- Bridges must not be stored directly on the ground. Make sure to place sufficient cribbing under the bottom chords to prevent damages to the bottom of the structure.
- 3- Avoid storing a bridge in a location with direct exposure to aggressive or corrosive materials in the surroundings.

Storage of a twin mast adapter

- 1- Make sure the locking pins have been removed and that plates have been unhooked. Make sure locking pins have been properly stored (attached to provided chains welded on the bridge structure, fig. 8.18).
- 2- Inspect the structure of the twin mast adapter, including the inside of the open-end tubes, for any sign of damage or distortion. Clean the twin mast adapter and its components thoroughly to limit the effects of any corrosive agent.
- 3- Twin mast adapters must not be stored directly on the ground. Make sure to place sufficient cribbing under the bottom chords to prevent damages to the bottom of the structure.
- 4- Avoid storing a twin mast adapter in a location with direct exposure to aggressive or corrosive materials in the surroundings.

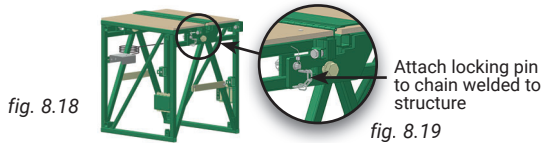

Storage of a mast section

- 1- Inspect the structure of each mast section, including the inside of the open-end tubes, for any sign of damage or distortion. Clean each mast section and its components thoroughly to limit the effects of any corrosive agent.
- 2- Mast sections must be stored on a flat surface away from work areas and construction traffic, vertically or horizontally.
- 3- Avoid storing mast sections in a location with direct exposure to aggressive or corrosive materials in the surroundings.

Storage of a guardrail

- 1- Inspect the structure of the guardrail, including the inside of the open-end tubes, for any sign of damage or distortion. Clean the guardrail thoroughly to limit the effects of any corrosive agent.
- 2- When possible, store the guardrail on the bridge or unit it was provided with. Guardrails must not be stored directly on the ground. Make sure to place sufficient cribbing under the guardrails to prevent damages to the structure.
- 3- Avoid storing guardrails in a location with direct exposure to aggressive or corrosive materials in the surroundings.

Transport and Storage

Storage of the access stairs

- 1- Inspect the structure of the access stairs, railings and extension(s), including the inside of the open-end tubes, for any sign of damage or distortion. Clean the access stairs, railings and extension(s) thoroughly to limit the effects of any corrosive agent.
- 2- Access stairs, railings and extensions must not be stored directly on the ground. Make sure to place sufficient cribbing under the access stairs to prevent damages to the bottom of the structure.
- 3- Avoid storing the access stairs, the railings and the extensions in a location with direct exposure to aggressive or corrosive materials in the surroundings.

Storage of the control post

- 1- Pull the spring latch (fig. 8.21) and slide in the control post until it is completely inside its storage location.
- 2- Make sure the spring latch is engaged and locks the control post in place.

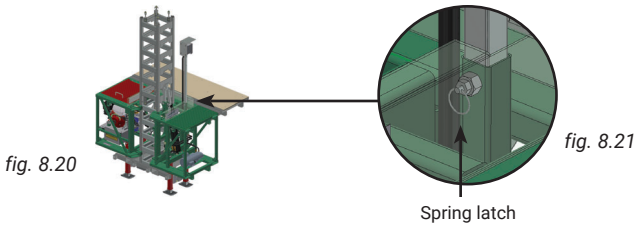

Storage of the motorized unit

- 1- Follow all steps of the preparation procedure on p. 56 of this section.
- 2- Inspect the structure of the motorized unit for any sign of damage or distortion. Clean the motorized unit thoroughly to limit the effects of any corrosive agent.
- 3- Before storing the motorized unit, make sure to place sufficient cribbing under the base to prevent damages to the bottom of the structure.
- 4- Choose an appropriate storage location. Avoid storing the motorized unit in a location with direct exposure to aggressive or corrosive materials in the surroundings.



NOTICE

Before transporting or storing a motorized unit, make sure that the gasoline valve lever has been moved to the OFF position. Disconnect the battery if the motorized unit is to be stored for any significant length of time.

Transport and Storage

Lifting and moving a motorized unit or a setup

The lift and relocation of a P Series narrow motorized unit or setup must be carried out with extreme care, using appropriate, certified lifting equipment.

Safety guidelines

- 1- The **maximum length** of a P Series narrow motorized unit setup that can be lifted and transported by a **rough terrain forklift** (by the base, using the forklift tubes) or a **crane** (using slings) is 37' 6" (11,4 m), weighing approximately 4200 lb (1905 kg).
- 2- **Before** lifting and transporting a motorized unit **setup**, it is **mandatory** to remove any installed access stairs.
- 3- When lifting a **setup by the mast with slings** (fig. 8.25), it is allowed to have **one additional mast section left in place** on top of the mast section welded on the base.
- 4- When lifting a **setup using the forklift tubes**, it is **important** to make sure that the rear platform extension is lowered and secured.
- 5- It is **mandatory** to refer to and comply with the capacities and limitations of the lifting device as specified by the manufacturer.
- 6- It is also **mandatory** to make sure that the weight of the setup is **equally balanced** on each side of the mast before lifting and transporting a motorized unit setup.

Preparation

- 1- In reference to the plan/layout drawing, establish the position where the motorized unit setup must be moved to and make sure that there are no obstacles.
- 2- Make sure that the lifting, transport and destination areas are clear of workers and equipment or any obstacle liable to interfere with the operation.



CAUTION

It is **mandatory** to remove any installed access stairs **before** lifting and transporting a motorized unit or setup.

Lifting a motorized unit or setup by the forklift tubes on the motorized unit

- 1- Prepare the motorized unit or setup as described in the safety guidelines and preparation instructions above.
- 2- Insert the forks in the forklift tubes located on the base of the motorized unit.
- 3- Lift and transport the motorized unit over to its destination area.

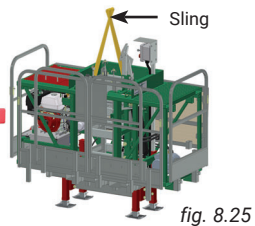
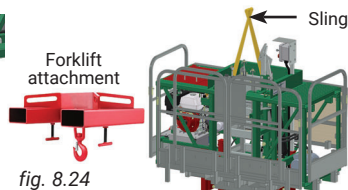
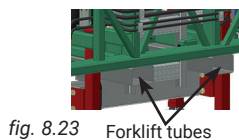
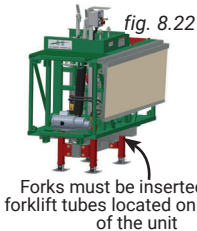

Lifting and moving a motorized unit or a setup by the mast – using a sling

- 1- Prepare the motorized unit or setup as described in the safety guidelines and preparation instructions above.
- 2- Make sure that there is no other mast section installed on top of the mast section welded on the base. When lifting a P Series narrow motorized unit by the mast, the sling must be attached to the mast section welded on the base.
- 3- Make sure the sling is appropriate for the weight to be lifted.
- 4- Secure the sling to the **top first rungs** of the mast section welded on the base. If using a forklift, make sure to use an appropriate forklift attachment to secure the sling (shown in fig. 8.24).
- 5- Make sure that two workers, wearing proper personal protection (PPE), are standing on the ground using tag lines to help stabilize the structure during the lift, transport and landing of the motorized unit.
- 6- Lift and transport the motorized unit or setup to its destination area.

Inspections and Maintenance

Proper maintenance and service will warrant safe, economical, and trouble-free operation of a P Series narrow motorized unit and its accessories. In order to ensure operational safety and avoid failures, the owner must make sure that all the scheduled inspection and maintenance operations have been effectively and timely carried out according to the inspection and maintenance schedules recommended for P Series motorized units and their accessories.

Blank copies of the daily inspection checklist must be available on job sites at all times to be filled out when daily and weekly inspection operations are carried out. Maintenance and inspection logs must be kept on record for warranty and safety purposes.

Copies of all maintenance and inspection checklists can be obtained by contacting the distributor/service center or downloaded directly from the Hydro Mobile website at www.hydro-mobile.com.

Inspection and maintenance of the cylinder hook

To ensure safe and trouble-free operation of the cylinder hook, it is **mandatory** to inspect it **as per the maintenance schedule**. A worn rubber must be replaced immediately, before operating the motorized unit. A worn and defective rubber will prevent the cylinder hook from working correctly and engage properly on mast rungs.

- 1- Hold the cylinder firmly (fig. 8.26) and pull the hook all the way back.
- 2- Let go of the hook and verify its position.
- 3- The hook **must not lean** towards or away from the mast, but **stand up straight** as in "B" in fig. 8.27. If the position of the hook is as in "A" or "C" in fig. 8.27, the rubber must be replaced immediately.

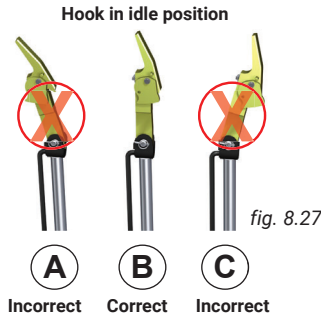
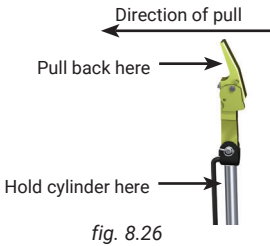

Replacement of the rubber of the cylinder hook

- 1- Remove the lynch pin and slide out the clevis pin (GR8) (fig. 8.28). Lift the hook from the cylinder.
- 2- Remove the defective rubber.
- 3- Cut **slight** beveled edges lengthwise on the replacement rubber (see fig. 8.29) so that it fits snugly against the welding tracks at the bottom of the pocket.
- 4- Insert the replacement rubber in the top part of the cylinder. Slide in the hook and verify that the holes in the hook and the holes in the top part of the cylinder align properly, with no more than 1/16" to 1/8" (1,6 mm to 3,2 mm) of play. **The rubber must be lightly compressed**. Trim the bottom part of the rubber until the holes align correctly.
- 5- Once the rubber fits correctly, replace the hook and secure it in place with the clevis and lynch pins.
- 6- Test the operation of the cylinder hook as described in steps 1 through 3 of the inspection instructions.

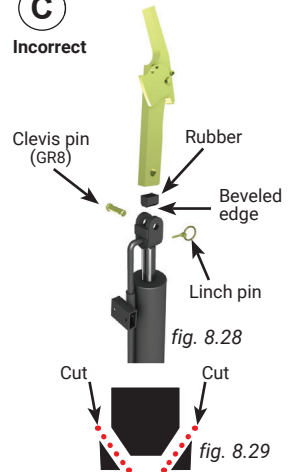

Cut beveled edges on the replacement rubber only deep enough for fitting

Inspections and Maintenance

Greasing the mast carriage guide rollers

To ensure safe and trouble-free operation, it is **mandatory** to grease each mast carriage roller (16) as part of the **weekly** inspection and maintenance operations.

A proper greasing will extend the life expectancy of the rollers. Rollers (shown in red in fig. 8.31) must be greased using only Prolab GS1000 grease.

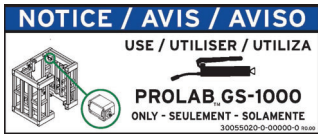

fig. 8.30

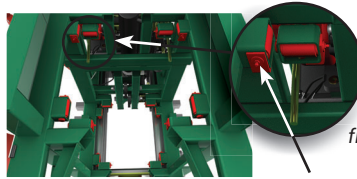

fig. 8.31 Rollers are shown in red for illustration purposes only

fig. 8.32

Grease must be applied here on each roller (16)

Inspecting and greasing the safety hooks

The safety hooks are an important part of the safety mechanism of a P Series mast climber and must be able to move freely at all times, and be in appropriate working condition. To ensure the proper operation of safety hooks, they must be inspected **daily** and greased as part of the **weekly** inspection and maintenance operations.

- 1- Inspect each safety hook (2) to make sure that there is no indication of a drop of the unit. If there are signs of a drop, each safety hook must be thoroughly inspected by a **qualified technician**. For the definition of a qualified technician, refer to p. 7 of the *Performance and Safety Rules* section.

It is mandatory to replace any triggered safety hook and its pivot bolt immediately before resuming operation of the unit. **The replacement of a safety hook must be performed by the qualified technician.**

- 2- Inspect each safety hook to make sure that there is no indication of excessive grease. If there are signs of excessive grease, a **qualified technician** must take the safety hook apart and clean it properly.
- 3- Apply grease to each safety hook (2) as part of the **weekly** inspection and maintenance operation. Safety hooks must be greased using only Prolab GS1000 grease.

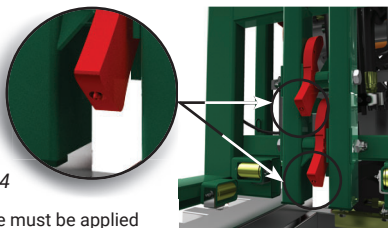

fig. 8.34

Grease must be applied here on each safety hook (2)

Safety hooks are shown in red for illustration purposes only

Triggered safety hook
Pivot bolt

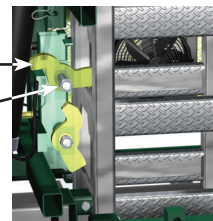

fig. 8.33

fig. 8.35

Any triggered safety hook and its pivot bolt must be replaced immediately before resuming operation of the unit

Inspections and Maintenance

Daily and Weekly Inspections and Maintenance

Daily and weekly inspections must be performed by a qualified operator. For more information about qualified operator, refer to p. 7 of the *Performance and Safety Rules* section.

Each Hydro Mobile motorized unit and its accessories must be submitted to daily (or before every working shift) and weekly inspections and maintenance operations performed by the qualified user/operator (see box above).

Daily and weekly inspection operations are only necessary when the motorized unit and its accessories are in use. The owner and/or user is responsible for all inspection and maintenance operations. Before being first used on a job site, a P Series narrow motorized unit and its accessories must be inspected effectively and timely, according to the schedules recommended for P Series narrow motorized units and their accessories.

Maintenance and inspection logs must be kept on record for warranty and safety purposes. Blank copies of the daily inspection checklist must be available on job sites at all times to be filled out when daily and weekly inspection operations are carried out. The notes and comments form must be used to indicate any discrepancy or any item found to be not acceptable. Any discrepancy must be reported to the owner/user. Appropriate corrective action must be taken immediately before the motorized unit can be used again. Corrective actions must be performed by qualified personnel.

Frequent Inspections and Maintenance

Frequent inspections must be performed by a qualified technician. For more information about qualified technicians, refer to p. 7 of the *Performance and Safety Rules* section.

Each Hydro Mobile motorized unit must be submitted to a frequent inspection performed every three months by a qualified technician (see box above).

Maintenance and inspection logs must be kept on record for warranty and safety purposes. Blank copies of the frequent inspection checklist must be filled out when frequent inspection operations are carried out. The notes and comments form must be used to indicate any discrepancy or any item found to be not acceptable. Any discrepancy must be reported to the owner, the user and the competent person. Appropriate corrective action must be taken immediately before the motorized unit can be used again. Corrective actions must be performed by a qualified technician.

All inspection and maintenance steps included in the daily inspection checklist must be performed before the frequent inspection and maintenance steps.

It is recommended to use replacement parts manufactured by or recommended by Hydro Mobile. The use of substitute parts could not only void the warranty covering this motorized unit and its components but cause serious damages that could lead to injury or death. It is recommended to replenish and grease components only with fluids and lubricants recommended by Hydro Mobile.



WARNING

Any equipment, accessory or component found or suspected to be non compliant with inspection requirements must not be used before it has been duly inspected and deemed compliant. Any discrepancy must be reported to the owner, the user and the competent person. Appropriate corrective action must be taken immediately before the motorized unit can be used again. Corrective actions must be performed by a qualified technician.

Inspections and Maintenance

Annual Inspections and Maintenance

Annual inspections must be performed by a qualified technician. For more information about qualified technicians, refer to p. 7 of the Performance and Safety Rules section.

Each Hydro Mobile motorized unit must be submitted to an annual inspection performed by a qualified technician (see box above). This annual inspection must be carried out **no later than 13 months after the previous annual inspection**.

Maintenance and inspection logs must be kept on record for warranty and safety purposes. Blank copies of the annual inspection checklist must be filled out when annual inspection operations are carried out. The notes and comments form must be used to indicate any discrepancy or any item found to be not acceptable. Any discrepancy must be reported to the owner, the user and the competent person. Appropriate corrective action must be taken immediately before the motorized unit can be used again. Corrective actions must be performed by a qualified technician.

It is recommended to use replacement parts manufactured by or recommended by Hydro Mobile. The use of substitute parts could not only void the warranty covering this motorized unit and its components but cause serious damages that could lead to injury or death. It is recommended to replenish and grease components only with fluids and lubricants recommended by Hydro Mobile.

Copies of inspection and maintenance checklists shown below can be obtained by contacting the distributor/service center or the Hydro Mobile technical support team or downloaded directly from the Hydro Mobile website at www.hydro-mobile.com.

Daily and weekly inspection checklist

The form is titled 'DAILY INSPECTION CHECKLIST' and includes a warning icon. It contains a list of inspection items with corresponding checkboxes and a grid for recording dates and results.

fig. 8.36

Frequent inspection checklist

The form is titled 'FREQUENT INSPECTION CHECKLIST' and includes a warning icon. It contains a list of inspection items with checkboxes and a grid for recording dates and results.

fig. 8.37

Annual inspection checklist

The form is titled 'ANNUAL INSPECTION CHECKLIST' and includes a warning icon. It contains a list of inspection items with checkboxes and a grid for recording dates and results.

fig. 8.38

Copies of the job survey checklist and the handover checklist shown below can be obtained by contacting the distributor/service center or the Hydro Mobile technical support team or downloaded directly from the Hydro Mobile website at www.hydro-mobile.com.

The form is titled 'JOB SURVEY - JOB HAZARD ANALYSIS' and includes a warning icon. It contains a detailed survey form with sections for job information, hazard analysis, and safety measures.

fig. 8.39

The form is titled 'INSTALLATION HANDOVER SHEET' and includes a warning icon. It contains a detailed handover form with sections for equipment information, installation details, and safety instructions.

fig. 8.40

Inspections and Maintenance

Stickers

All Hydro Mobile manufactured equipment is shipped with stickers providing owners and users with information and warnings that are essential for a safe and optimal use of the equipment.

In the course of a frequent inspection, the qualified technician must make sure that each sticker is present and legible. Any missing or illegible sticker must be replaced before the motorized unit is used. For more information about qualified technicians, refer to p. 7 of the *Performance and Safety Rules* section.

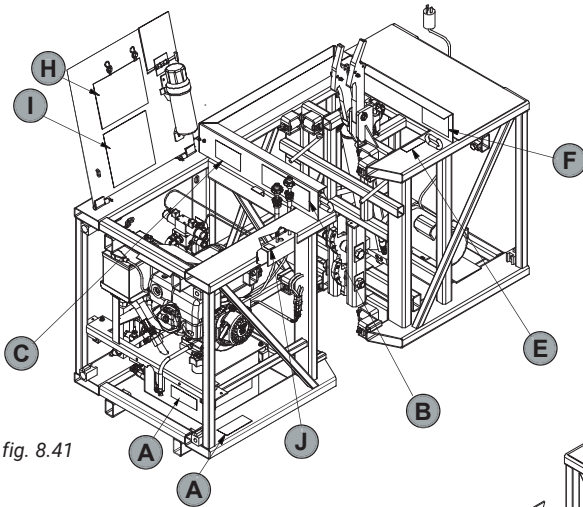

fig. 8.41

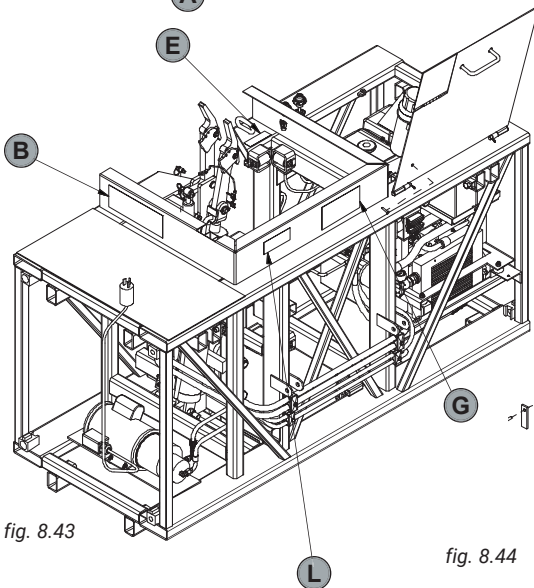

fig. 8.43

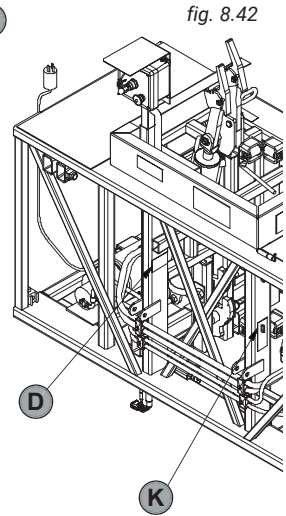

fig. 8.42

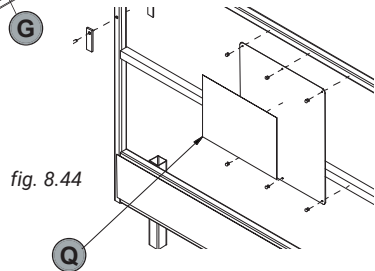

fig. 8.44

Inspections and Maintenance

Stickers

General information stickers



PART NUMBER: A0800600-0001 *fig. 8.45*



fig. 8.46

Hazards warning stickers



fig. 8.47

PART NUMBER: 30055010-0-00000-0



fig. 8.48

PART NUMBER: 30055000-0-00000-0

Operation instructions stickers

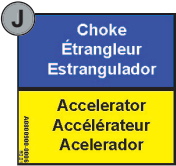

fig. 8.49

PART NUMBER: A0800900-0006

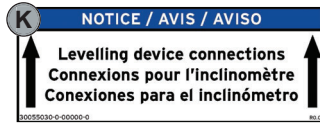
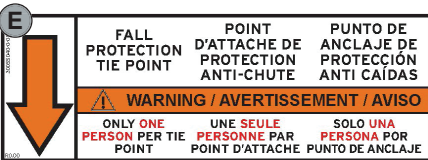

fig. 8.50

PART NUMBER: 30055030-0-00000-0

Ties, mast, anchoring, fall protection and load capacities



PART NUMBER: A0800000-0015 *fig. 8.51*



PART NUMBER: 11055030-0-00000-0 *fig. 8.52*



fig. 8.53

PART NUMBER: 11055020-0-00000-0

Inspections and Maintenance

Stickers

Ties, mast, anchoring, fall protection and load capacities

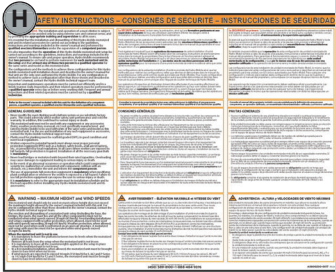

fig. 8.54

PART NUMBER: A0800200-0017

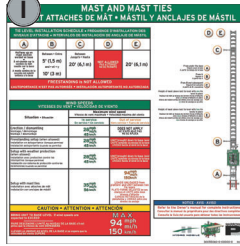

fig. 8.55

PART NUMBER: 30055060-0-00000-0

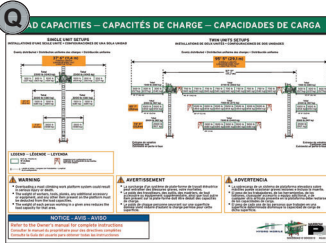

fig. 8.56

PART NUMBER: 30055060-0-00000-0

Inspection validation and maintenance stickers



PART NUMBER: 30055020-0-00000-0

fig. 8.57

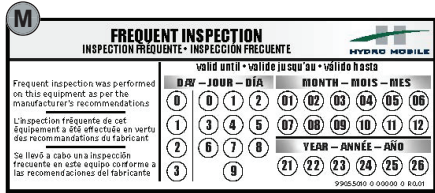

PART NUMBER: 99055010-0-00000-0

fig. 8.58



PART NUMBER: 99055000-0-00000-0

fig. 8.59



PART NUMBER: 99055030-0-00000-0

fig. 8.60

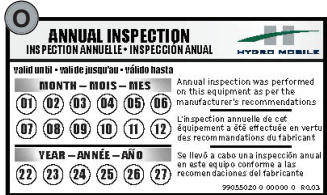

PART NUMBER: 99055020-0-00000-0

fig. 8.61

Inspections and Maintenance

Hydraulic Diagram V6

# ITEM	CODE	DESCRIPTION
1	T1031400-K-02000-0	ENGINE HONDA 9 HP KIT - M2
2	A0411500-0009	ENGINE HYDRAULIC GEAR PUMP PLP 10-8 (P)
3	A0470203-0009	VALVE CHECK CVT-04-SAE
4	A0470204-0001	VALVE RELIEF CARTRIDGE TYPE (RV5-10)
5	A0470210-0006	VALVE DIRECTIONAL ELECTRIC 12VDC - P
6	A0580000-0001	CYLINDER 3 1/2x23 1/2x1 1/2
7	A0470200-0000	VALVE COUNTERBALANCE SUN 3000 PSI(W/CAP)
8	T1018102-0-00000-0	CYLINDER ASS'Y - M2
9	30031202-0-00000-0	HYDRAULIC OIL COOLER ASS'Y 2015 KBV
10	30031600-0-01000-0	EMERGENCY ELEC. MOTOR 110V SUB ASS'Y - P
11	A0471704-0003	12 SAE PORT FILTER HOUSING
12	A0410000-0004	ENGINE FILTER ELEMENT (MP FILTR)

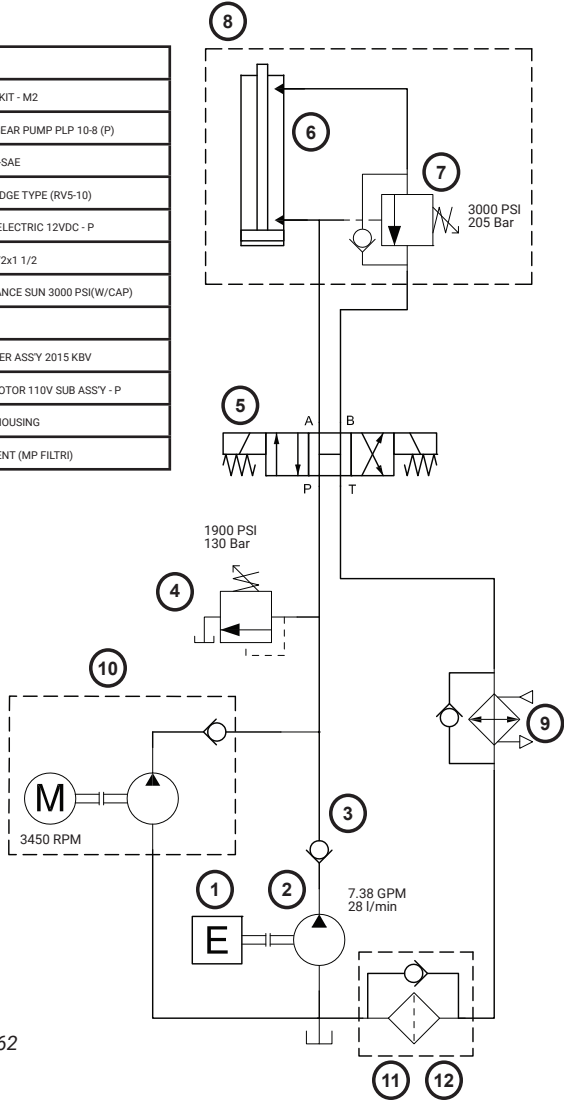

fig. 8.62

Inspections and Maintenance
Electrical Diagram for V6 units

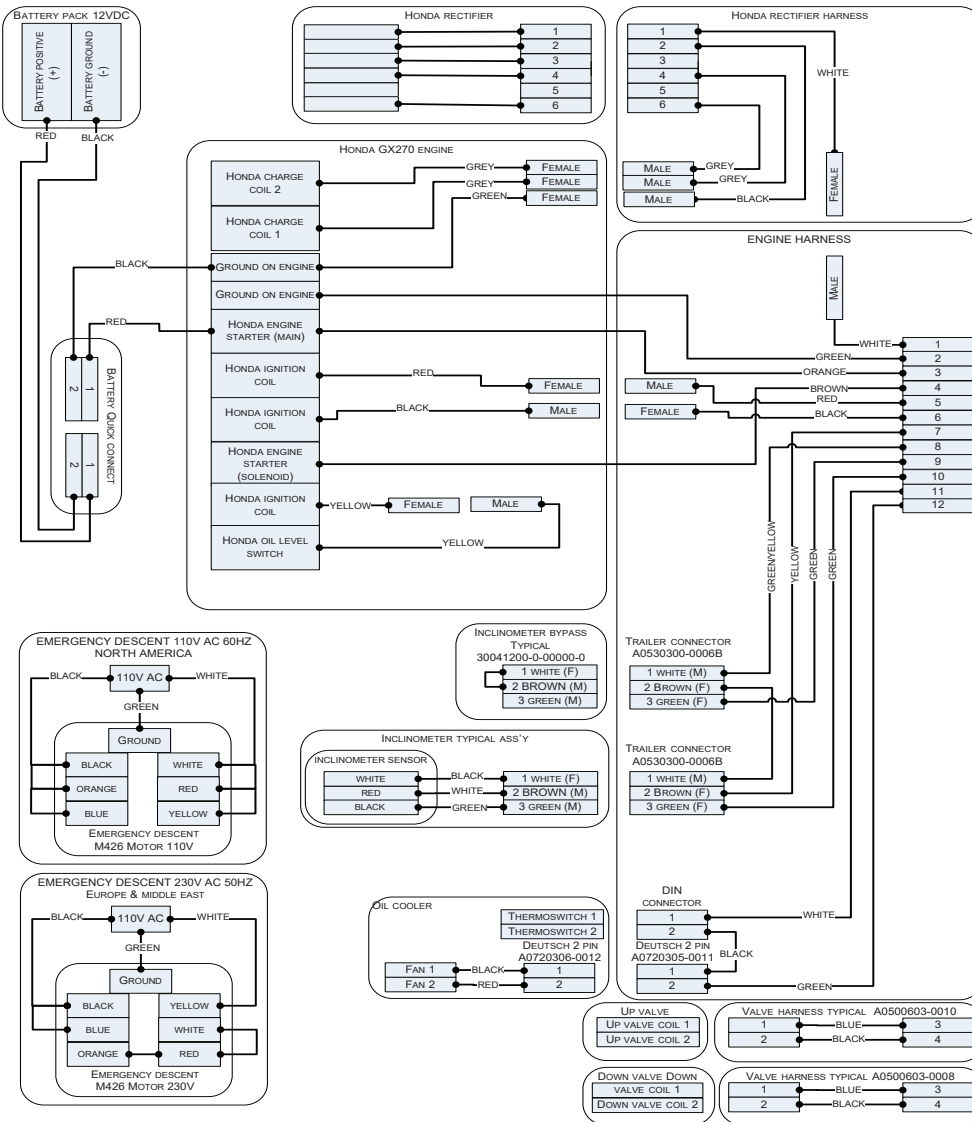

fig. 8.63

Inspections and Maintenance
Electrical Diagram for V6 units

